



CONSTRUCCION
GRIFERIA
MATIZADOS
VIDRIERIA
SEGURIDAD INDUSTRIAL
LIGHTING
AUTOMOTRIZ
CERRAJERIA
CONSUMO MASIVO



CATÁLOGO 2024



INDICE



01 CONSTRUCCION

MALLA OLIMPICA
BROCAS
PICO Y ZAPAPICO
PALAS SCHUBERT
COMBAS S/MANGO
COMBAS CON MANGO D/FIBRA
MALLA DE SEGURIDAD
ALAMBRE GALVANIZADO
MANGA DE RIEGO

PROTECTOR FACIAL "SCHUBERT"
GUANTES DE SEGURIDAD "SCHUBERT"
LENTES DE SEGURIDAD "SCHUBERT"
CARTUCHOS "SCHUBERT"
PROTECTOR AUDITIVO "SCHUBERT"
VIDRIO PARA SOLDAR "SCHUBERT"
CHALECOS DE SEGURIDAD "SCHUBERT"
TRIÁNGULO DE SEGURIDAD "SCHUBERT"
LETRERO DE ADVERTENCIA
CONOS DE PLÁSTICO "SCHUBERT"

02 SEGURIDAD INDUSTRIAL

03 GRIFERÍA

CONEXIONES GALVANIZADAS
LLAVE DE COMPUERTA "SCHUBERT"
VÁLVULAS ESFÉRICAS
VÁLVULA JENKIS "SCHUBERT"
VÁLVULA YORK "SCHUBERT"
UNIÓN SIMPLE "SCHUBERT"
UNIÓN UNIVERSAL "SCHUBERT"
LLAVE ESFÉRICA "SCHUBERT" / "FIJI"
LLAVE ESFÉRICA P/BOTADERO "SCHUBERT"
CINTA TEFLÓN "FIJI"

RODILLO P/PINTAR
PINCEL DE CERDA T/PLANO
PINTURA SPRAY "SCHUBERT"
PINTURA SPRAY "FIJI"

04 MATIZADOS

PINTURAS EN SPRAY
FIJI

TOP LIGHT
FOCOS LED

S SCHUBERT

VALVULAS

Vera
TIMBRES

PAOX
CARRETIILLAS Y PALAS

FIJI LIGHT
LED

First Cable
CABLE COAXIAL - UTP

BESTLUX

INDICE



05 VIDRIERÍA

SILICONAS EN CARTUCHO "SCHUBERT".

FOCO LED
EQUIPO FLUORESCENTE LED CON SWITCH
TOMACORRIENTE E INTERRUPTORES "TOP LIGHT"
ENCHUFE MÚLTIPLE "TOP LIGHT"
TOMACORRIENTE "FIJI LIGHT"
CANALETA "SCHUBERT"
CANALETA "PAOX"
CANALETA "FIJI".
PANTALLA ACRÍLICA LED "BESTLUX"
EQUIPO FLUORESCENTE LED "BESTLUX"
EQUIPO FLUORESCENTE "TOP LIGHT"
PANTALLA ALUMINIZADA "TOP LIGHT"
EQUIPO LINEAL LED "TOP LIGHT"
PANTALLA ACRÍLICA "FIJI LIGHT"
PANTALLA LED CON REJILLA "FIJI LIGHT"
LED OVALADO "BESTLUX"
PANEL CIRCULAR "FIJI LIGHT"
PANEL CUADRADO "FIJI LIGHT"
CIRCULAR LED "TOP LIGHT"
HIGH BAY "BESTLUX"
PANEL LED DOWNLIGHT "TOP LIGHT"
PANTALLA BALDOSA "TOP LIGHT"
LÁMPARA COLGANTE "TOP LIGHT"
LED WALL "TOP LIGHT"
REFLECTOR "BESTLUX"
REFLECTOR "FIJI LIGHT"
LÁMPARA DE EMERGENCIA "TOP LIGHT"
LÁMPARA DE EMERGENCIA DELUXE "SCHUBERT"
LÁMPARA LED PORTÁTIL "SCHUBERT"
LINTERNA CON BLUETOOTH "SCHUBERT"
LINTERNA LED 3 EN 1 "SCHUBERT"
TIMBRE INDUSTRIAL "SCHUBERT"
SENSOR DE MOVIMIENTO "SCHUBERT"
LED NEÓN STRIP "TOP LIGHT"
BATERÍA PARA CELULARES "SCHUBERT"
CABLES PARA CELULARES "SCHUBERT".
CARGADOR DE AUTO "SCHUBERT"

06 LIGHTING



INDICE



07 AUTOMOTRIZ

SILICONA PARA CUEROS Y TABLEROS
LLANTAS PARA MOTOCICLETA "FIJI"
INFLADOR "SCHUBERT"
ABRAZADERA SIN FIN
HERRAMIENTAS
PRECINTO DE NYLON
GATAS "SCHUBERT"

REMACHADORA "SCHUBERT"
REMACHES DE ALUMINIO "SCHUBERT"
SARGENTA T/F "SCHUBERT"
BISAGRA "SCHUBERT"
BISAGRA "FIJI"
CANDADO CON ALARMA "SCHUBERT"
CORREDERA PARA CAJÓN "SCHUBERT"
CORREDERA TELESCÓPICA "CON FRENO "PAOX"
CORREDERA TELESCÓPICA CON FRENO "SCHUBERT"
PISTON A GAS "SCHUBERT"
CERRADURA PARA VITRINA "SCHUBERT"
ZIGZAG D/RODILLO
CIERRE MAGNÉTICO
ESCUADRA PARA REPISA "SCHUBERT"

08 CERRAJERÍA

09 CONSUMO MASIVO

CUCHILLA CUTTER "SCHUBERT"
LLAVEROS "SCHUBERT"
STRECHT FILM
GATILLO SPRAYER
TERMÓMETRO ANU





CONSTRUCCIÓN

- MALLA OLIMPICA
- BROCAS
- PICO
- PALAS SCHUBERT
- COMBASS/MANGO
- COMBAS CON MANGO D/FIBRA
- MALLA DE SEGURIDAD
- ALAMBRE GALVANIZADO
- MANGA DE RIEGO

CONSTRUCCIÓN

CONSTRUCCION

LINEA 093

HERRAMIENTAS "SCHUBERT"



PICOS "SCHUBERT"

CODIGO	MEDIDA	UND. MED.	MASTER
093007	5 LB. NEGRO	UNIDAD	6 UND.

PALAS "SCHUBERT"

CODIGO	DESCRIP.	UND. MED.	MASTER
093001	T/CUCHARA	UNIDAD	6 UND.
093002	T/RECTA	UNIDAD	6 UND.

CONSTRUCCION

LINEA 171

MALLA OLÍMPICA



MALLA OLÍMPICA

CODIGO	MEDIDA	ALAMBRE	UND. MED.	MASTER
171002	2x20m x 54kg.	BWG 12	ROLLO	1 RLL.



CONSTRUCCION

LINEA 093

HERRAMIENTAS "SCHUBERT"



COMBA D/ACERO CON MANGO FIBRA D/VIDRIO



CODIGO	MEDIDA	UND. MED.	MASTER
118002	4 LB.	UNIDAD	12 UND.
118003	6 LB.	UNIDAD	4 UND.
118004	8 LB.	UNIDAD	4 UND.
118005	10 LB.	UNIDAD	4 UND.
118006	12 LB.	UNIDAD	2 UND.
118007	14 LB.	UNIDAD	2 UND.
118008	16 LB.	UNIDAD	2 UND.
118009	18 LB.	UNIDAD	2 UND.
118010	20 LB.	UNIDAD	2 UND.
118020	22 LB.	UNIDAD	2 UND.
118018	24 LB.	UNIDAD	2 UND.

COMBA D/ACERO SIN MANGO

CODIGO	MEDIDA	UND. MED.	MASTER
142002	3 LB.	UNIDAD	20 UND.
142003	4 LB.	UNIDAD	16 UND.
142009	14 LB.	UNIDAD	4 UND.
142010	16 LB.	UNIDAD	4 UND.
142013	18 LB.	UNIDAD	3 UND.
142014	22 LB.	UNIDAD	3 UND.
142012	24 LB.	UNIDAD	3 UND.



CONSTRUCCION

LINEA 067

ALAMBRE GALVANIZADO



Alambre con buen baño de galvanizado.

Resistente a la corrosión.

Disponible en diferentes medidas.

Diámetro uniforme a todo lo largo del rollo.

Rollos continuos, sin cortes.

Para usos en cercas lisas, artesanales, industriales, jaulas, etc.

ALAMBRE GALVANIZADO "SCHUBERT"

CODIGO	MEDIDA	PESO	UND. MED.	MASTER
067001	# 10	25 KG.	KG.	1 ROLLO
067002	# 12	25 KG.	KG.	1 ROLLO
067003	# 14	25 KG.	KG.	1 ROLLO
067004	# 16	25 KG.	KG.	1 ROLLO
067005	# 18	25 KG.	KG.	1 ROLLO
067006	# 20	10 KG.	KG.	1 ROLLO
067007	# 22	10 KG.	KG.	1 ROLLO

✉ ventas@pymintegralsolutions.com

☎ 992 405 560

UNIDAD DE NEGOCIO:

CONSTRUCCION

LINEA 092

BROCAS "SCHUBERT"



BROCAS HSS PULGADAS



CODIGO	MEDIDA	UND. MED.	CAJA
092011	1/32"	UNIDAD	10 UND.
092023	1/16"	UNIDAD	10 UND.
092018	5/64"	UNIDAD	10 UND.
092019	7/64"	UNIDAD	10 UND.
092013	5/32"	UNIDAD	10 UND.
092021	11/64"	UNIDAD	10 UND.
092024	3/16"	UNIDAD	10 UND.
092014	7/32"	UNIDAD	10 UND.
092025	5/16"	UNIDAD	10 UND.
092029	3/8"	UNIDAD	10 UND.
092026	7/16"	UNIDAD	5 UND.
092027	9/16"	UNIDAD	1 UND.

BROCAS HSS MILIMETROS



CODIGO	MEDIDA	UND. MED.	CAJA
092001	1 MM	UNIDAD	10 UND.

UNIDAD DE NEGOCIO:

CONSTRUCCION

LINEA 092

BROCAS "SCHUBERT"



BROCAS HSS COBALTO

P/ACERO INOXIDABLE, ALUMINIO



CODIGO	MEDIDA	UND. MED.	CAJA
092087	3/64"	UNIDAD	10 UND.
092085	11/64"	UNIDAD	10 UND.

BROCAS SDS PLUS (MM.)

PIEDRA, CONCRETO
P/ROTOMARTILLOS



CODIGO	MEDIDA	UND. MED.	CAJA
092057	13.0x160x100mm	UNIDAD	1 UND.

BROCA P/CONCRETO PREMIUM, BLISTER ROJO

CODIGO	MEDIDA	UND. MED.	MASTER
092084	7/16"	UNIDAD	1 UND.



FIJI

MALLA DE SEGURIDAD



Características

- Confeccionado en polietileno de alta densidad.
- Color naranja visible a gran distancia.
- Flexible y fácil de instalar

Aplicaciones:

- Protección en excavaciones.
- Control de tráfico.
- Delimitación de áreas peligrosas

Peso:

- 2.75 Kg.

CODIGO	DESCRIPCIÓN	MEDIDA	UND. MED.	PAQUETE
255001	MALLA DE SEGURIDAD NARANJA	1 x 45 m	ROLLO	1 UND.

FIJI



MANGA DE RIEGO

Permiten conducir el agua y distribuirla a través de salidas equidistantes con caudales controlados. Este sistema mejora la eficiencia de distribución y aplicación.

Beneficios:

- . Uniformidad de goteo
- . Peso ligero
- . Buena flexibilidad

Características:

1. Espesor de cinta es de 0.18mm (180 micrones)
2. Material y revestimiento: material de PE
3. Flujo de agua de 3 litros por hora.
4. Longitud: 1,000 m



! Recomendaciones:

- Para evitar estos daños se recomienda:
- No dejarlas expuestas al sol sin necesidad
 - Vaciar completamente las mangas antes de moverlas
 - Cuidar que no la pisen animales
 - Después de la temporada guardarlas sin agua y enrolladas.

CODIGO	DESCRIPCION	UND. MED.	PAQUETE
241001	MANGA P/RIEGO 5/8" x 1000 mt	UNIDAD	1 ROLLO



SEGURIDAD INDUSTRIAL

- GUANTES DE SEGURIDAD
- LENTES DE SEGURIDAD
- CARTUCHOS
- PROTECTOR AUDITIVO
- VIDRIO PARA SOLDAR
- CHALECOS DE SEGURIDAD
- TRIÁNGULO DE SEGURIDAD
- LETRERO DE ADVERTENCIA
- CONOS DE PLÁSTICO



SEGURIDAD INDUSTRIAL

UNIDAD DE NEGOCIO:

SEGURIDAD INDUSTRIAL

PROTECTOR RES FACIALES



PROTECTOR FACIAL CASCO MEDIALUNA



CODIGO	TIPO D/ CASCO.	INTERNA	MASTER
124039	MEDIALUNA	1 UND.	40 UND.

PROTECTOR FACIAL CASCO COMPLETO



CODIGO	TIPO D/ CASCO.	INTERNA	MASTER
124038	COMPLETO	4 UND.	24 UND.

PROTECTOR FACIAL PLÁSTICO C/AMARILLO

CODIGO	DESCRIP.	INTERNA	MASTER
124040	PLÁSTICO	1 UND.	40 UND.



UNIDAD DE NEGOCIO:

SEGURIDAD INDUSTRIAL

GUANTES Y LENTES DE SEGURIDAD



GUANTES CON PUNTOS PVC

COD:	UND. MED	INTERNA	MASTER
199004	PAR	12 PARES	240 PARES



LENTE P/SOLDAR MOVIBLE

CODIGO	COLOR	INTERNA	MASTER
124017	VERDE	1 UND.	50 UND.



LENTES DE SEGURIDAD TRANSP.

CODIGO	DESCRIP.	BLISTER	MASTER
124005	LIVIANA	1 UND.	200 UND.



LENTES DE SEGURIDAD

CODIGO	DESCRIP.	BLISTER	MASTER
124007	C/TRANSP.	1 UND.	200 UND.

UNIDAD DE NEGOCIO:

SEGURIDAD INDUSTRIAL

PROTECCIÓN INDUSTRIAL



CARTUCHO C/GASES Y VAP. ORGAN. E INORG.

CODIGO	COLOR	INTERNA	MASTER
124026	AZUL	6 UND.	300 UND.
124028	PLATEADO	6 UND.	300 UND.



CARTUCHO QUÍMICO

CODIGO	COLOR	INTERNA	MASTER
124029	VERDE	6 UND.	600 UND.



MASCARILLA CON FILTRO 1 VIA

CODIGO	DESCRIP.	INTERNA	MASTER
124024	DELGADO	1 UND.	50 UND.
124025	GRUESO	1 UND.	50 UND.



MASCARILLA C/FILTRO 1 VIA

CODIGO	COLOR	MASTER
124033	AZUL	120 UND.

UNIDAD DE NEGOCIO:

SEGURIDAD INDUSTRIAL

PROTECCIÓN INDUSTRIAL



PROTECTOR AUDITIVO

CODIGO	COLOR	INTERNA	MASTER
124021	ROJO	1 PAR	40 UND.
124041	AMARILLO	1 PAR	40 UND.



VIDRIO P/SOLDAR

CODIGO	DESCRIP.	INTERNA	MASTER
124043	CUADRADO #10	100 UND.	400 UND.
124044	RECTANG. #13	100 UND.	400 UND.
124035	REDONDO #4	100 UND.	400 UND.

UNIDAD DE NEGOCIO:
SEGURIDAD

SEG. INDUSTRIAL "SCHUBERT"



CHALECOS DE SEGURIDAD

EN ISO 20471:2013 Alta Visibilidad
Chaleco de seguridad reflectante
Bandas reflectantes de ancho 50mm
Fabricado 100% poliéster
Talla: XL

MODELO: SC-02



. Con bolsillos

MODELO: SC-03



MODELO: SC-04



- . 16 led proporciona una gran visibilidad
- . Cuenta con un botón on/off
- . Ubicación clara a los caminantes, automovilistas, ciclistas, excursionistas, etc



atrás

Medida:
Largo 65cm x 66cm Ancho (+/- 1cm)



atrás

Medida:
Largo 71,5cm x 59cm Ancho (+/- 1cm)



atrás

Medida:
Largo 57cm x 55cm Ancho (+/- 1cm)

- USA 2 PILAS AA
(No incluye)

- 3 modos de luces
(intermitente, parpadeo lento y luz constante)



TRIÁNGULO DE SEGURIDAD

Gran visibilidad que permite advertir a los conductores en las pistas y carreteras.

Soporte resistente a los impactos

Fácil armado, plegable.

Presentación en estuche

CODIGO	DESCRIPCION	MODELO	UND. MED.	MASTER
252001	CHALECO DE SEGURIDAD	SC-02	UNIDAD	50 UND.
252002	CHALECO DE SEGURIDAD	SC-03	UNIDAD	50 UND.
252003	CHALECO DE SEGURIDAD C/ LUCES LED	SC-04	UNIDAD	50 UND.
252004	TRIÁNGULO DE SEGURIDAD C/ROJO	SC-05	UNIDAD	20 UND.

SEGURIDAD IND.



Letrero de Advertencia

PLEGABLE Y TRANSPORTABLE



Señal de precaución
'CUIDADO PISO MOJADO'



Código: 252005



Código: 224011



Diseño profesional,
letras grandes y
de ALTA CALIDAD.

CODIGO	DESCRIPCION	MODELO	UND. MED.	MASTER
252005	LETRERO DE ADVERTENCIA	SC-06	UNIDAD	20 UND.
224011	LETRERO DE ADVERTENCIA	LZL-AB-03	UNIDAD	20 UND.

SEGURIDAD IND.



CONO DE PLASTICO

CON CINTA REFLECTIVA



CODIGO	DESCRIPCION	UND. MED.
224001	CONO DE PLASTICO 18" "SCHUBERT"	UNIDAD
224003	CONO DE PLASTICO 36" "SCHUBERT"	UNIDAD

SEGURIDAD IND.



CONO DE PLASTICO

SIN CINTA REFLECTIVA



CODIGO	DESCRIPCION	UND. MED.
238003	CONO DE PLASTICO 36" SIN CINTA REFLECTIVA	UNIDAD

GRIFERÍA

- DE SAGÜE DE PLÁSTICO
- TUBO DE ABASTO
- TAPÓN
- VÁLVULAS
- TEE GALVANIZADO
- UNIÓN SIMPLE
- CHECK SWING
- CINTA TEFLÓN
- LLAVE ESFÉRICA
- CAÑO P/LAVATOP



GRIFERÍA

UNIDAD DE NEGOCIO:

GRIFERÍA

LINEA 068, 031, 210

CONEXIONES Y LLAVE



**VÁLVULA
JENKIS 1/2"
"SCHUBERT"**

CODIGO	INTERNA	MASTER
031030	12 UND	120 UND



**DESAGÜE DE
PLÁSTICO
P/LAVATORIO
1 1/4" X 8"**

CODIGO
210005

MASTER
40 UND.



**TAPÓN HEMBRA
GALVANIZADO**

CODIGO	MEDIDA	MASTER
068015	3/4"	520 UND
068010	1"	240 UND
068011	1 1/2"	100 UND



**TAPÓN MACHO
GALVANIZADO**

CODIGO	MEDIDA	MASTER
068020	1/2"	1,000 UND
068017	1"	380 UND
068018	1 1/2"	160 UND
068023	3/4"	600 UND
068021	2"	120 UND
068022	3"	30 UND

UNIDAD DE NEGOCIO:

GRIFERÍA

LINEA 031, 133

VÁLVULAS Y LLAVES



**UNIÓN SIMPLE
GALVANIZADO
SCHUBERT**

CODIGO	MEDIDA	MASTER
068037	1 1/4"	115 UND
068036	1 1/2"	60 UND
068039	2"	45 UND
068044	6"	2 UND



**TEE GALVANIZADO
"SCHUBERT"**

CODIGO	MEDIDA	MASTER
068032	3/4"	120 UND
068028	1 1/4"	50 UND
068027	1 1/2"	40 UND
068030	2"	24 UND



**VÁLVULA
ESFÉRICA
"FIJI"**

CODIGO	MEDIDA	INTERNA	MASTER
133003	1/2"	12 UND	120 UND
133005	1"	8 UND	80 UND



**CHECK SWING
HORIZONTAL
1" FIJI**

CODIGO
133010

MASTER
60 UND.

TUBOS DE ABASTO



**TUBO DE ABASTO
REFORZADO
DE ALUMINIO
1/2"x7/8"x40cm
R/PVC**



Beneficios:

- Tubo de abasto especialmente diseñado para lavatorios , termas , inodoro con función de suministro de agua.
- Trenzado, brinda máxima resistencia

CODIGO	MEDIDA	UND. MED.	BO LSA INTERNA	C.J. MASTER
198002	TUBO DE ABASTO 1/2" x 7/8" x 40 cm R/PVC	UNIDAD	10 UND.	150 UND.

UNIDAD DE NEGOCIO:
GRIFERÍA

LINEA 031

LLAVE ESFÉRICA



LLAVE ESFÉRICA P/JARDÍN

- . Llave esférica para jardín, especial para usos con conexiones de manguera.
- . Llave cromada, semi pesada
- . Chorro con dirección, caída precisa.

CODIGO	MEDIDA	INTERNA	MASTER
031001	1/2"	12 UND.	120 UND.



LLAVE ESFÉRICA P/BO TADERO

- . Llave esférica para botadero, especial para usos en lavaderos.
- . Llave cromada, semi pesada
- . Chorro con caída abierta.

CODIGO	MEDIDA	INTERNA	MASTER
031002	1/2"	12 UND.	120 UND.

UNIDAD DE NEGOCIO:

GRIFERÍA

LINEA 031

CINTA TEFLÓN



CINTA TEFLÓN

LINEA 031



Beneficios:

- Buena resistencia a las rasgadas.
- Sella tuberías de pernos roscados metálicos y de plástico.

CODIGO	DESCRIPCION	UND. MED.	CJ. INTERNA	CJ. MASTER
031058	CINTA TEFLON 1/2" x 12 MTS	UNIDAD	200 UND.	1000 UND.

UNIDAD DE NEGOCIO:

GRIFERÍA

LINEA 166

CAÑO PARA LAVATORIO



CAÑO PARA LAVATORIO CROMADO

MODELO: CF1025

Características:

- . Caño cromado, excelente presentación.
- . Cierre de medio giro.
- . Fácil de instalar

CODIGO	MEDIDA	UND. MED.	CJA. INTERNA	CJA. MASTER
166006	1/2"	UNIDAD	8 UND.	80 UND.



INTEGRAL
SOLUTIONS S.R.L.C.

MATIZADOS

- RODILLO
- PINCELES
- BROCHAS
- SPRAY SCHUBERT



PINTURAS EN SPRAY
SCHUBERT

MATIZADOS

MATIZADOS



RODILLOS PARA PINTAR

Rodillo de alta calidad ideal para USO con pintura látex.

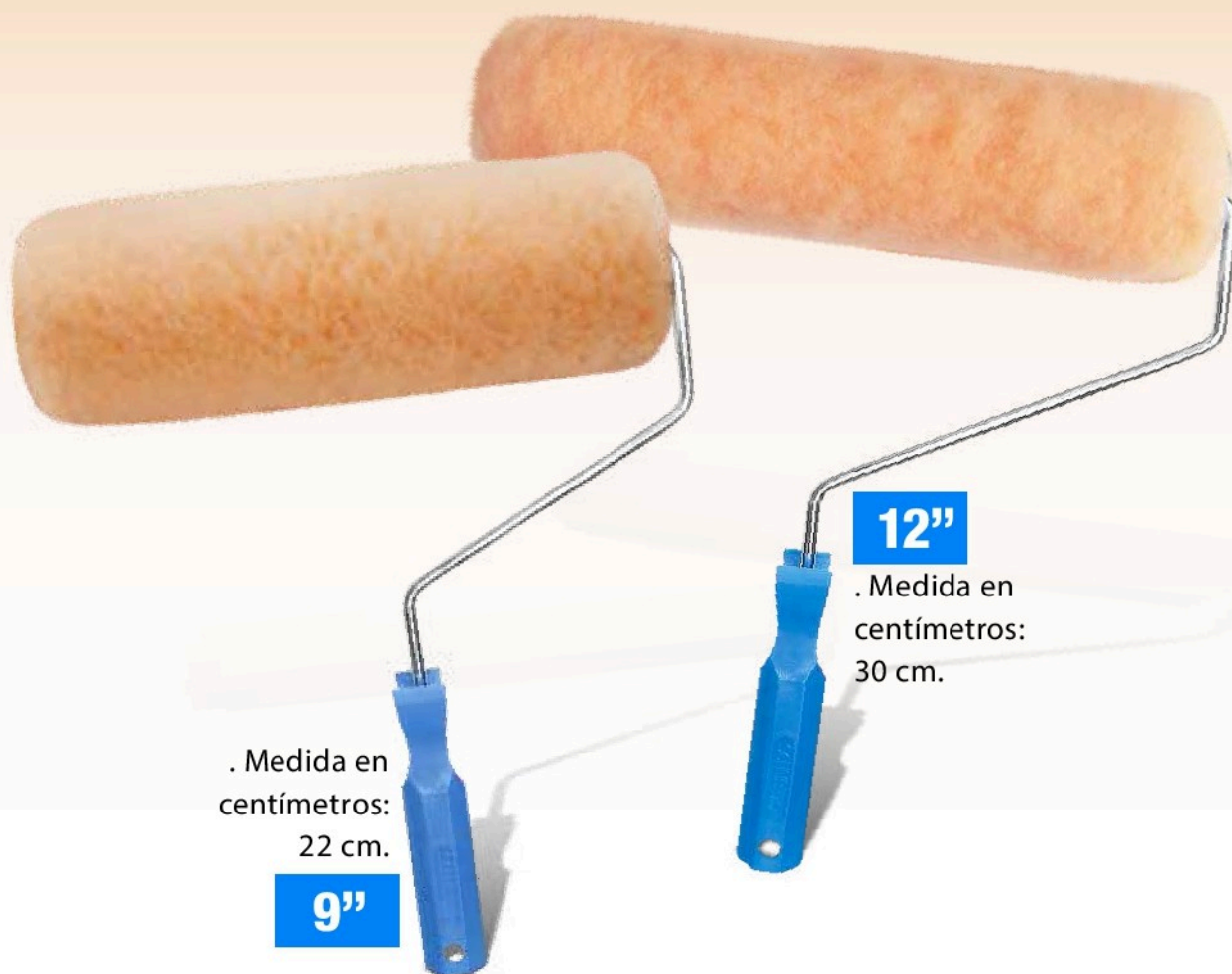

. Medida en centímetros:
22 cm.

9"

12"

. Medida en centímetros:
30 cm.

CODIGO	DESCRIPCION	UNID. MED.	CAJA MASTER
033029	RODILLO P/PINTAR MELÓN 9" "SCHUBERT"	UNIDAD	50 UNID.
033030	RODILLO P/PINTAR MELÓN 12" "SCHUBERT"	UNIDAD	50 UNID.

MATIZADOS



RODILLOS PARA PINTAR

Rodillo de alta calidad ideal para pintura epóxica, esmaltes y barnices.

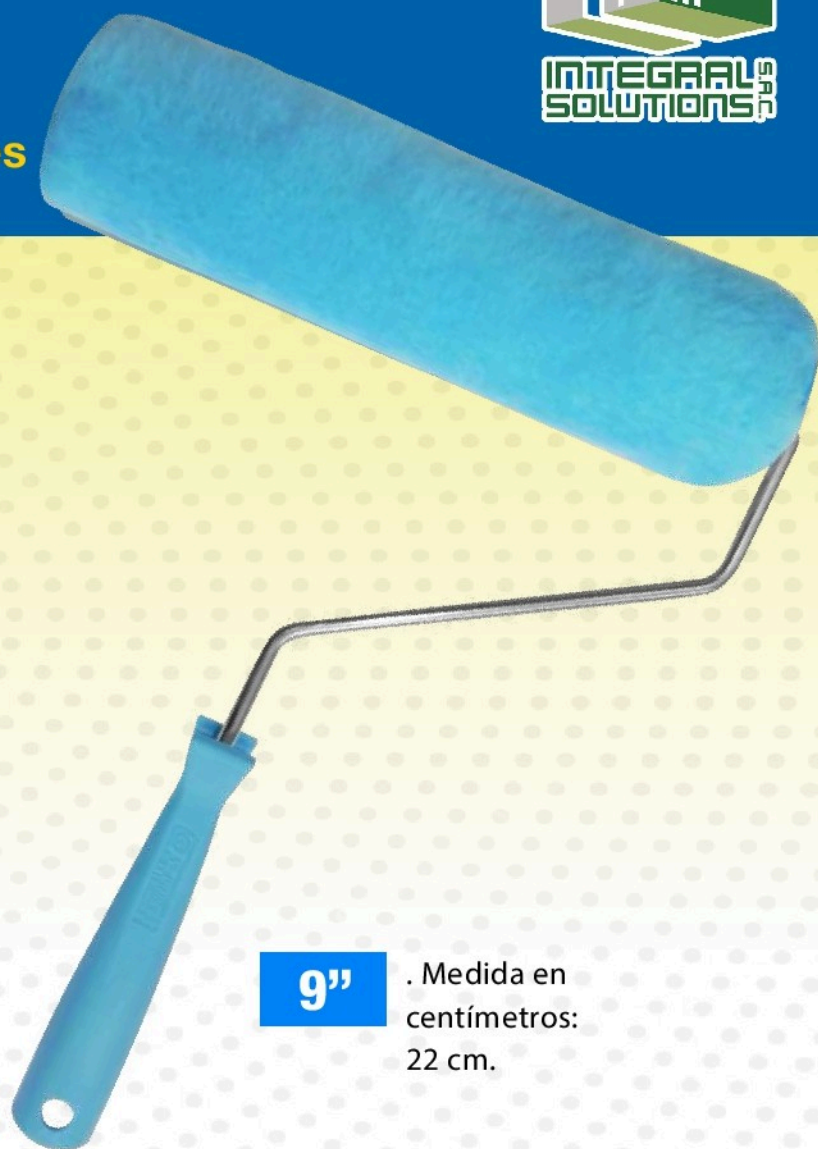

9"

. Medida en centímetros: 22 cm.

- Alta resistencia a solventes, antigoteo.

Usos: Para pintar todo tipo de superficies tales como: señalizaciones de tránsito, demarcación de áreas, bermas, tubos y zonas con difícil acceso.

CODIGO	DESCRIPCION	UNID. MED.	CAJA MASTER
033032	RODILLO P/PINTAR CELESTE 9" "SCHUBERT"	UNIDAD	50 UNID.

MATIZADOS

LINEA 033

BROCHAS "SCHUBERT"



BROCHAS DE NYLON

CODIGO	MEDIDA	UND. MED.	CAJA	MASTER
033001	1/2"	DOCENA	12 DOC.	30 DOC.
033002	3/4"	DOCENA	12 DOC.	30 DOC.
033003	1"	DOCENA	12 DOC.	30 DOC.
033004	1 1/2"	DOCENA	12 DOC.	30 DOC.
033005	2"	DOCENA	12 DOC.	30 DOC.
033006	2 1/2"	DOCENA	12 DOC.	30 DOC.
033007	3"	DOCENA	12 DOC.	30 DOC.
033009	5"	DOCENA	6 DOC.	12 DOC.
033010	6"	DOCENA	6 DOC.	12 DOC.

UNIDAD DE NEGOCIO:

MATIZADOS

LINEA 033

BROCHAS "SCHUBERT"



PINCEL DE CERDA T/PLANO

CODIGO	MEDIDA	UND. MED.	CAJA	MASTER
033011	#0	DOCENA	12 DOC.	50 DOC.
033012	#2	DOCENA	12 DOC.	50 DOC.
033014	#6	DOCENA	12 DOC.	50 DOC.
033015	#8	DOCENA	12 DOC.	50 DOC.
033016	#10	DOCENA	12 DOC.	50 DOC.
033017	#12	DOCENA	12 DOC.	50 DOC.
033018	#14	DOCENA	12 DOC.	50 DOC.
033020	#18	DOCENA	12 DOC.	50 DOC.
033022	#22	DOCENA	12 DOC.	50 DOC.

MATIZADOS



PINTURAS EN SPRAY

. Atomizador libre, permite un mejor disparo y cubrimiento de la zona.



CODIGO	DESCRIPCION	UND. MED.	CAJA
132008	PINTURA SPRAY AMARILLO LIMON #41 "SCHUBERT"	UND	12 UND
132010	PINTURA SPRAY AZUL CLARO #35 "SCHUBERT"	UND	12 UND
132014	PINTURA SPRAY AZUL MARTILLO # 309 "SCHUBERT"	UND	12 UND
132017	PINTURA SPRAY BLANCO ANTIGUO # 19 "SCHUBERT"	UND	12 UND
132019	PINTURA SPRAY BLANCO OSTRA #2514 "SCHUBERT"	UND	12 UND
132001	PINTURA SPRAY BLANCO BRILLANTE # 16 "SCHUBERT"	UND	12 UND
132002	PINTURA SPRAY BLANCO MATE #20 "SCHUBERT"	UND	12 UND
132022	PINTURA SPRAY CATERPILLAR MD #51 "SCHUBERT"	UND	12 UND
132025	PINTURA SPRAY COBRE # 28 "SCHUBERT"	UND	12 UND
132026	PINTURA SPRAY CREMA (CREAM YELLOW) # 33 "SCHUBERT"	UND	12 UND
132030	PINTURA SPRAY FLUORESCENTE MAGENTA # 1012 "SCHUBERT"	UND	12 UND
132031	PINTURA SPRAY FLUORESCENTE VIOLET # 1013 "SCHUBERT"	UND	12 UND
132033	PINTURA SPRAY GRIS AZULADO #83 "SCHUBERT"	UND	12 UND
132037	PINTURA SPRAY LACA TRANSPARENTE #31 "SCHUBERT"	UND	12 UND
132038	PINTURA SPRAY MANDARINA # 68 "SCHUBERT"	UND	12 UND
132039	PINTURA SPRAY MARFIL # 18 "SCHUBERT"	UND	12 UND
132043	PINTURA SPRAY NARANJA #65 "SCHUBERT"	UND	12 UND
132003	PINTURA SPRAY NEGRO BRILLANTE #11 "SCHUBERT"	UND	12 UND
132004	PINTURA SPRAY NEGRO MATE #12 "SCHUBERT"	UND	12 UND
132047	PINTURA SPRAY ROJO FLUORESCENTE #103 "SCHUBERT"	UND	12 UND
132048	PINTURA ROJO FUEGO #73 "SCHUBERT"	UND	12 UND
132049	PINTURA ROJO OSCURO #75 "SCHUBERT"	UND	12 UND
132005	PINTURA SPRAY SILVER #36 "SCHUBERT"	UND	12 UND



VIDRIERÍA

- SILICONA EN
CARTUCHO



VIDRIERÍA

UNIDAD DE NEGOCIO:

VIDRIERÍA





LINEA 088

SILICONAS "SCHUBERT"



SILICONA EN CARTUCHO

CARACTERÍSTICAS:

-  Capacidad: 235 ml.
-  Sellador de Silicona
-  Secado normal, buena calidad
-  Fácil aplicación
-  Usos en: cristalería, metales, aplicaciones en baños y cocinas.

CODIGO	COLOR	UND. MED.	MASTER
088002	TRANSP.	UNIDAD	24 UND.

LIGHTING

- EQUIPO FLUORESCENTE
- TOMACORRIENTE
- INTERRUPTOR
- PANTALLA ACRÍLICA
- FOCOS LED
- CANALETAS
- PANTALLAS
- PANELES
- EQUIPO LINEAL
- BALDOSAS
- LÁMPARAS DE EMERGENCIA
- LINTERNAS
- TIMBRE INDUSTRIALES

LIGHTING



FIJI

CABLE UTP



- Cable UTP categoría 6E y 5E
- Diseñado para instalaciones interiores de red internet.
- Cubierta exterior: PVC
- Número total de conductores: 8 conductores
- Medida: 305 mt



CODIGO	DESCRIPCION	MEDIDA	UND. MED.	CJ. MASTER
225001	CABLE UTP CAT 5E	305 mt.	UNIDAD	1 UND.

TOP LIGHT



LIGHTING

FOCOS LED

LED

➤ LÍNEA 148

Características

- Alta calidad de iluminación.
- Dura mucho más: 15,000 hrs de uso.
- Bajo consumo de energía.
- Reduce el cansancio visual.
- Encendido instantáneo y sin pestañeo.
- Resistente al impacto.
- Cuida el medio ambiente.



Equivalencia:

9 W 80 WTS

CODIGO

MEDIDA

UND. MED.

MASTER

148015

9 W

UNIDAD

50 UND.

TOP LIGHT

FOCO MULTICOLOR CON BLUETOOTH

LED



Bluetooth



Control Remoto



7
WTS



Escucha tu
música favorita



CODIGO	DESCRIPCION	UND. MED.	CJ. MASTER
213002	FOCO MULTICOLOR CON BLUETOOTH	UND.	50 UNID.

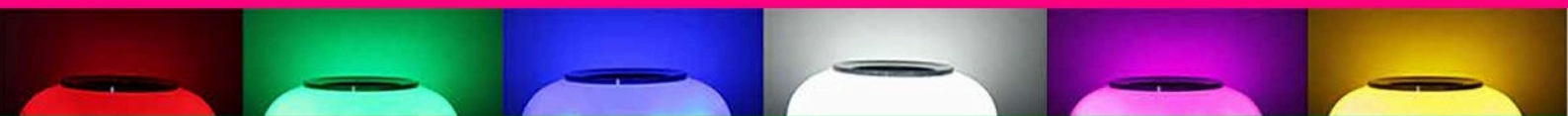

BESTLUX

FOCOS LED



15,000 Hrs

Larga DURACIÓN



Ahorro de ENERGÍA



Encendido INSTANTÁNEO



12 W



9 W



7 W



5 W

Características:

- . Iluminación LED, ahorra energía
- . Luz constante, sin parpadeos
- . Ideal para dormitorios, pasillos, salas, hoteles, comercios, iluminación en general

CODIGO	MEDIDA	UND. MED.	CJ. MASTER
247001	5 WTS	UNIDAD	100 UND.
247002	7 WTS	UNIDAD	100 UND.
247003	9 WTS	UNIDAD	100 UND.
247004	12 WTS	UNIDAD	100 UND.

TOP LIGHT

LINEA 204

**EQUIPO FLUORESCENTE LED
CON SWITCH 8WT**

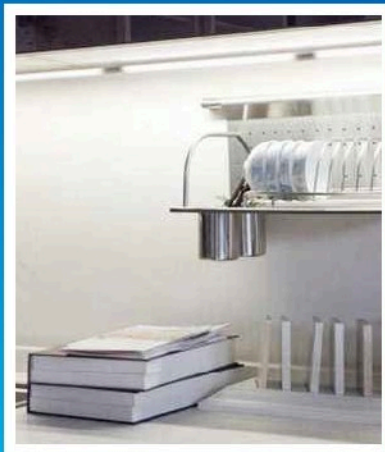
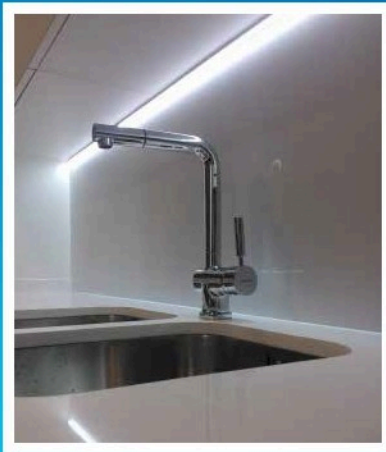
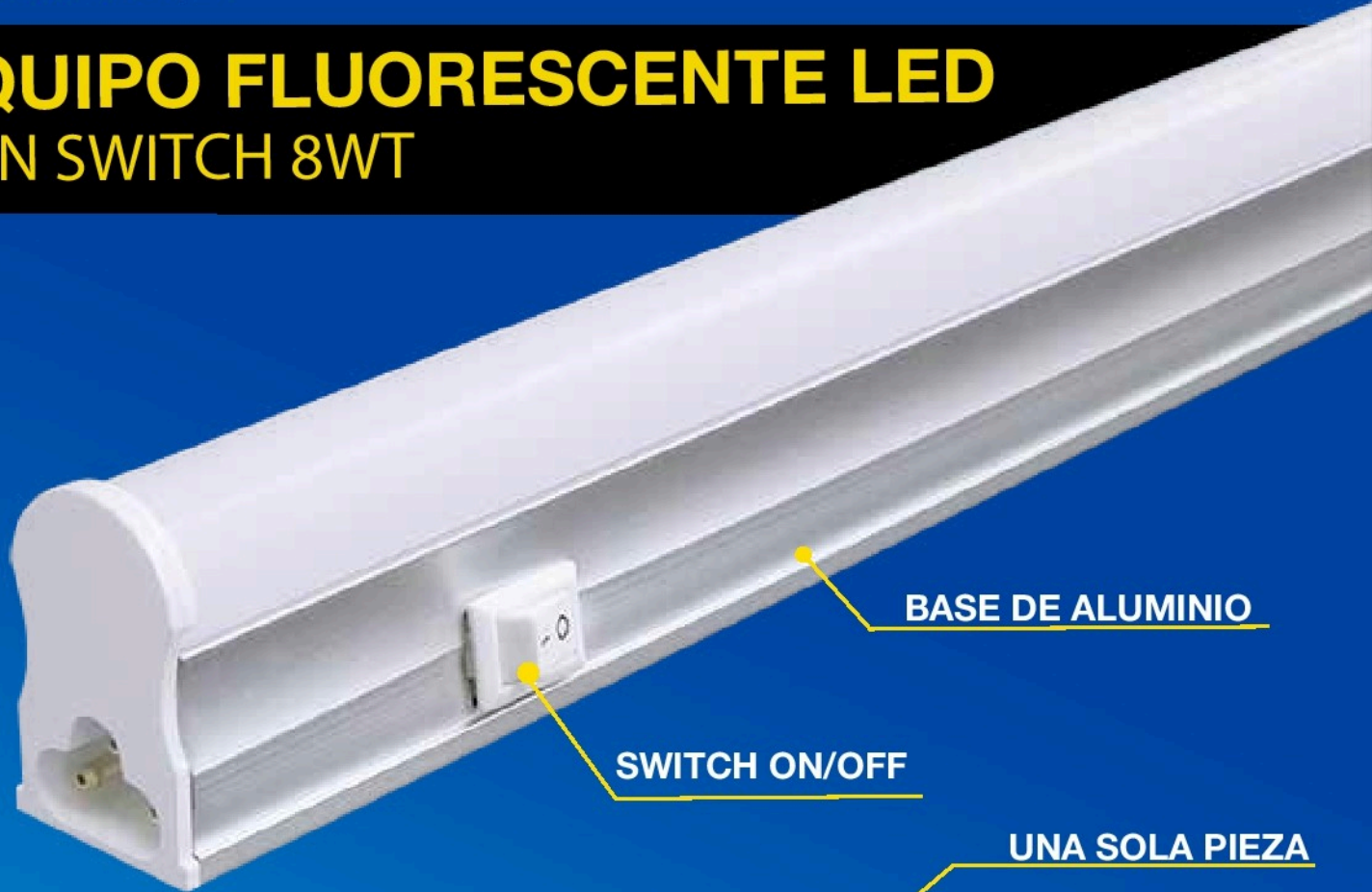

CODIGO	DESCRIPCIÓN	UND. MED.	MASTER
204003	EQUIPO FLUORESCENTE LED C/SWITCH 8WT	UNIDAD	30 UNIDADES

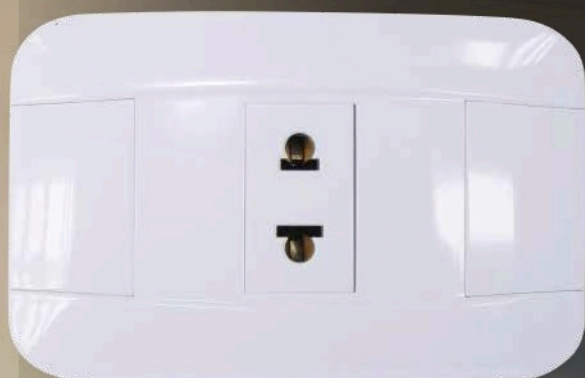

TOP LIGHT DELUXE

Tomacorriente simple Deluxe para empotrar

CODIGO	MODELO	UND. MED	C.J INTERNA	C.J MASTER
192001	V013	UNIDAD	10 UNID.	200 UNID.



TOP LIGHT DELUXE

Tomacorriente doble Deluxe para empotrar

CODIGO	MODELO	UND. MED	C.J INTERNA	C.J MASTER
192002	V015	UNIDAD	10 UNID.	200 UNID.



TOP LIGHT DELUXE

Tomacorriente telefonico para empotrar

CODIGO	MODELO	UND. MED	C.J INTERNA	C.J MASTER
192009	V023	UNIDAD	10 UNID.	200 UNID.

CANALETAS PVC CON PEGAMENTO 2 MT.

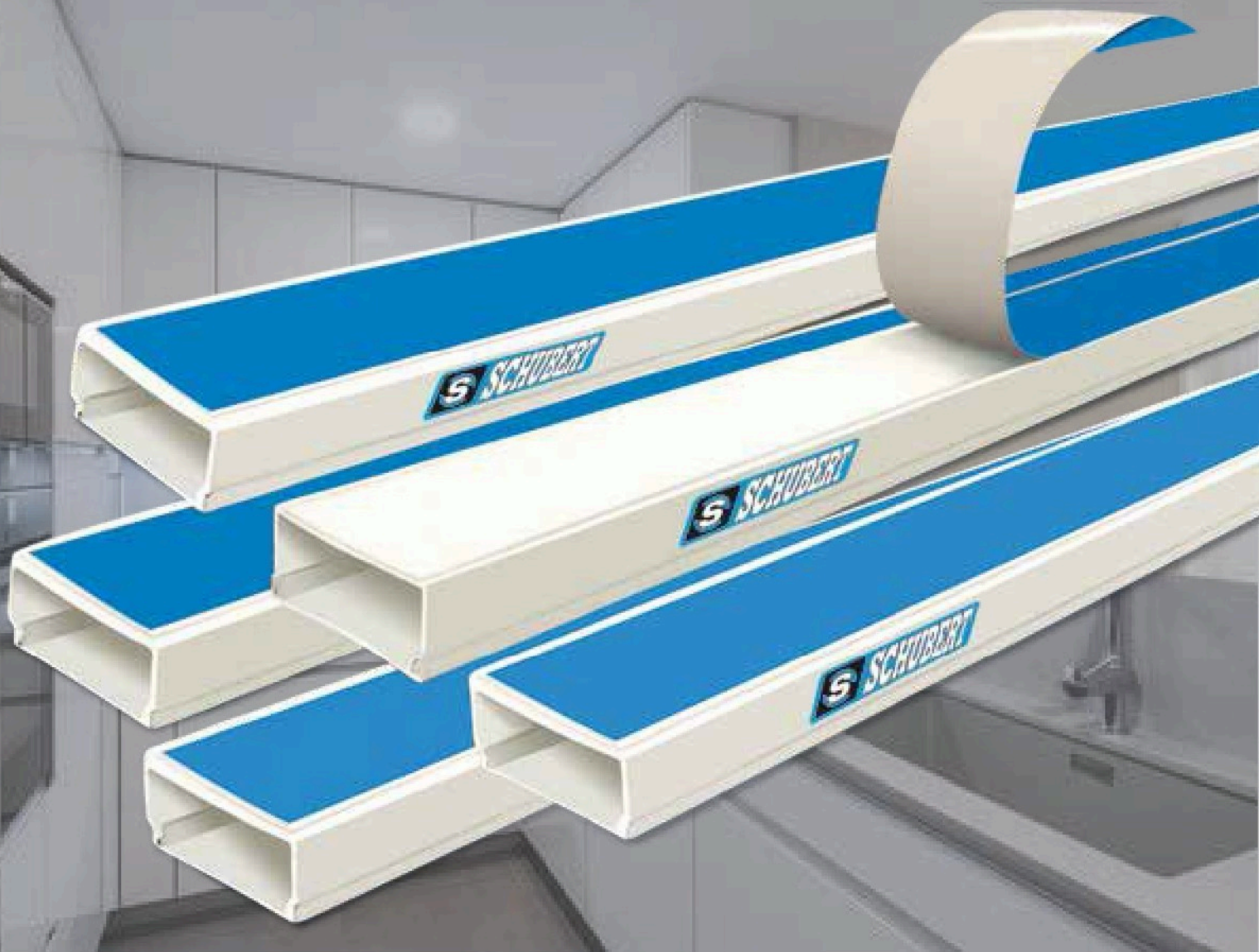

CODIGO	MEDIDA	UND. MED.	MASTER
123001	10 X 10	UNIDAD	50 UND.
123002	10 X 15	UNIDAD	30 UND.
123003	10 x 20	UNIDAD	30 UND.
123004	14 x 24	UNIDAD	25 UND.
123005	19 x 39	UNIDAD	15 UND.
123006	25 x 50	UNIDAD	10 UND.
123007	40 x 60	UNIDAD	6 UND.
123008	60 x 100	UNIDAD	2 UND.



PAOX

CANALETAS CON PEGAMENTO

LÍNEA 219

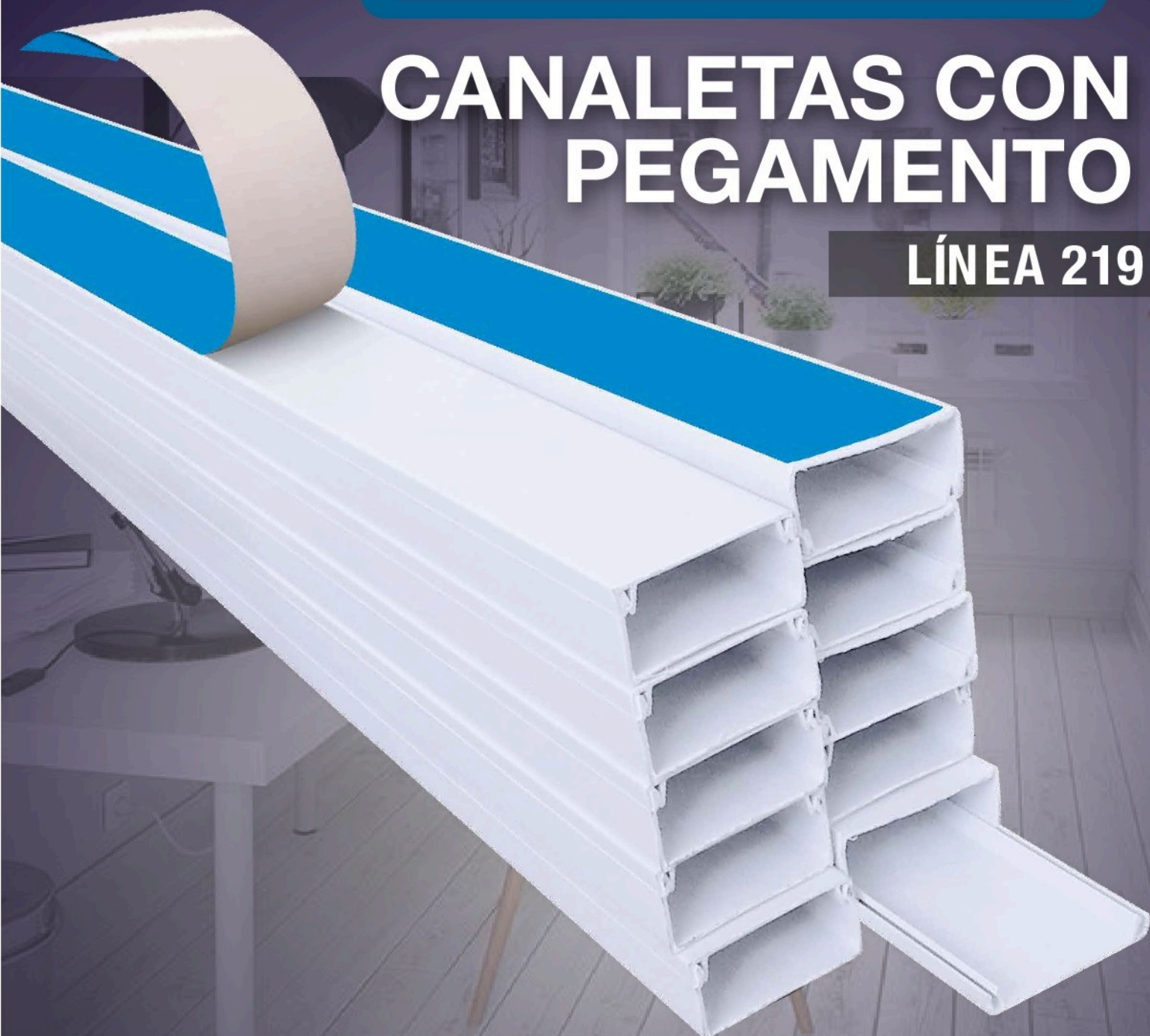

CODIGO	MEDIDA	UND. MED.	CJ. MASTER
219005	19 x 39	UNIDAD	15 UND.

BESTLUX

PANTALLA ACRÍLICA LED

Iluminación LED, ahorro de energía
Ideal para iluminación en talleres,
industrias, almacenes, túneles, garages,
laboratorios y áreas húmedas y
polvorientas en general.



**INCLUYE 1 BALASTO
ELECTRONICO**
NO NECESITA ARRANCADOR

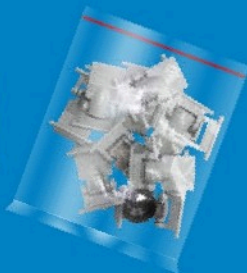

**INCLUYE
ACCESORIOS
PARA EL CIERRE**

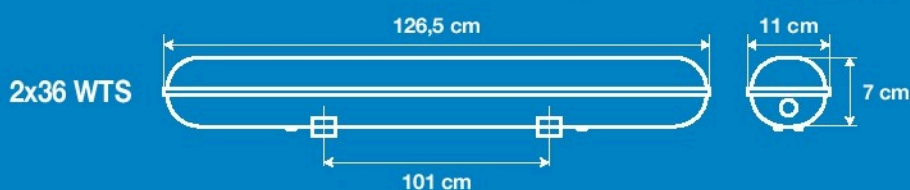

CODIGO	CONSUMO	UND. MED.	MASTER
248001	2 x 36 WTS	UNIDAD	8 UND.

TOP LIGHT



LIGHTING

EQUIPO FLUORESCENTE 1x36 WTS

➤ LÍNEA 162



INCLUYE 1 BALASTO ELECTRONICO
NO NECESITA ARRANCADOR

CARACTERÍSTICAS:

- Base para fluorescente convencional de 36WTS y 40WTS.
- Base fabricada en metal esmaltado con acabado de color blanco.
- Fácil instalación.
- Largo de 1.20 cm. y Ancho de 4.2 cm.
- Incluye accesorios (sockets y balasto).
- Presentación: caja master por 24 unidades.
- Medio de iluminación de uso más generalizado en comercios, oficinas, sitios públicos, viviendas.

CODIGO	DESCRIPCIÓN	UND. MED.	MASTER
162004	EQUIPO FLUORESCENTE 1x36 WTS	UNIDAD	24 UND.

TOP LIGHT



LIGHTING

PANTALLA ALUMINIZADA DE EMPOTRAR

➤ LÍNEA 162

No incluye los focos fluorescentes



Material:

- Acero Inoxidable, Aluminio, Plástico

Usos:

- Casa, oficina, hotel, exposición, biblioteca, salas de reuniones, dormitorios.

Características:

- Modelo empotrable.
- Elaborado en plástico duradero con proceso de pulverizado avanzado, pintura con una mejor resistencia a la corrosión.
- Ahorro de energía, sin ruidos, manteniendo un funcionamiento estable.
- Fácil instalación.
- Equipo apropiado para 4 tubos convencionales de 18 o 20 Wts.
- Equipo no incluye fluorescente.

FOTO INTERNA

NO INCLUYE BALASTO ELECTRÓNICO



PANTALLA ALUMINIZADA 4x18 WTS

CODIGO	MEDIDA	PESO	UND. MED.	MASTER
162002	59.5 x 59.5 x 7.2 cm	2.3 Kg.	UNIDAD	1 UND.

TOP LIGHT



LIGHTING

PANTALLA ALUMINIZADA 4x8 WTS FOCO LED

➤ LÍNEA 162

4x8
WTS
LED



Material:

- Acero Inoxidable, Aluminio, Plástico

Usos:

- Casa, oficina, hotel, exposición, biblioteca, salas de reuniones, dormitorios.

Características:

- Modelo empotrable.
- Elaborado en plástico duradero con proceso de pulverizado avanzado, pintura con una mejor resistencia a la corrosión.
- Equipo incluye 4 focos led y 1 balasto.
- Ahorro de energía, sin ruidos, manteniendo un funcionamiento estable.
- Fácil instalación.



INCLUYE
4 FOCOS LED



INCLUYE 1 BALASTO
ELECTRONICO

NO NECESITA ARRANCADOR

CODIGO

MEDIDA

PESO

UND. MED.

MASTER

162003

59.5 cm x 59.5 cm x 5.2 cm

2.0 Kg.

UNIDAD

1 UND.

TOP LIGHT



LIGHTING

PANTALLA ALUMINIZADA 4x9 WTS FOCO LED

➤ LÍNEA 162

4x9
WTS
LED



Material:

- Acero Inoxidable, Aluminio, Plástico

Usos:

- Casa, oficina, hotel, exposición, biblioteca, salas de reuniones, dormitorios.

Características:

- Modelo empotrable.
- Elaborado en plástico duradero con proceso de pulverizado avanzado, pintura con una mejor resistencia a la corrosión.
- Equipo incluye 4 focos led y 1 balasto.
- Ahorro de energía, sin ruidos, manteniendo un funcionamiento estable.
- Fácil instalación.



INCLUYE
4 FOCOS LED



INCLUYE 1 BALASTO
ELECTRONICO

NO NECESITA ARRANCADOR

CODIGO

MEDIDA

PESO

UND. MED.

MASTER

162012

59.5 cm x 59.5 cm x 5.2 cm

2.0 Kg.

UNIDAD

1 UND.

TOP LIGHT

EQUIPO LINEAL LED DELUXE

➤ LÍNEA 170

LED



Beneficios

Reúne todas las características y ventajas de la iluminación LED ahorro energía, mayor vida útil, **confort visual, alta eficiencia y encendido instantáneo.**

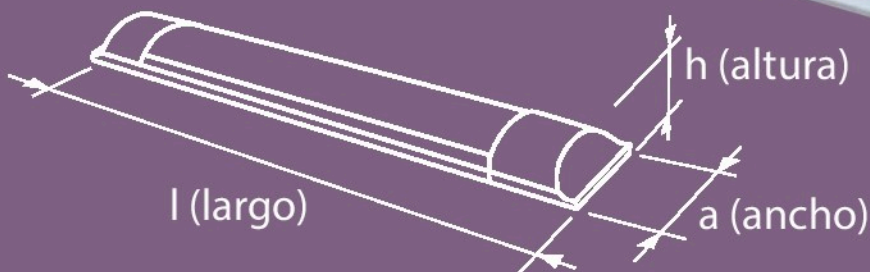

Medida:

- 2 x 36 wts (l)119.2 x (a)7.5 x (h)2.4 cm

2x36
WTS

CODIGO	DESCRIPCION	INTENSIDAD	UND. MED.	MASTER
170009	EQUIPO LINEAL LED DELUXE	2 x 36 WTS	UNIDAD	20 UND.

FIJI LIGHT



PANTALLA ACRILICA

Protector para lámpara fluorescente
Ideal para iluminación en talleres,
industrias, almacenes, túneles,
garages, laboratorios y áreas húmedas
y polvorientas en general.



NO INCLUYE
LOS FOCOS
FLUORESCENTES



INCLUYE 1 BALASTO
ELECTRONICO
NO NECESITA ARRANCADOR



INCLUYE ACCESORIOS
PARA EL CIERRE
HERMÉTICO



LADO POSTERIOR



CODIGO	CONSUMO	UND. MED.	MASTER
230001	2 x 36 WTS	UNIDAD	8 UND.
230002	2 x 18 WTS	UNIDAD	8 UND.

FIJI LIGHT

LED

PANTALLA LED CON REJILLA

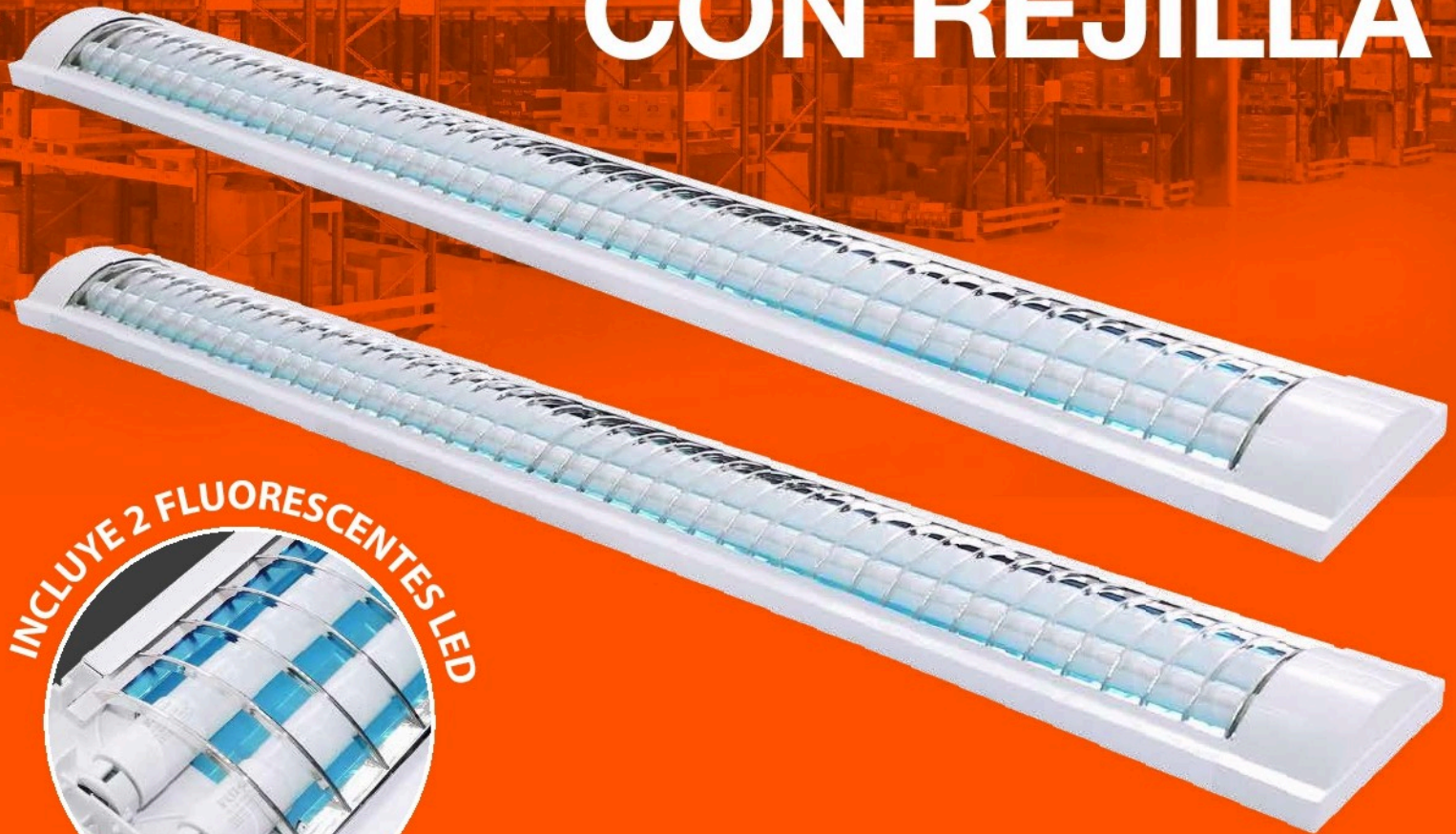

APLICACIONES:

Panel Lineal LED con Rejilla.
Para uso en colegios, almacenes, hospitales,
edificios, oficinas, locales comerciales,
estadios, bancos, Etc.

2x36
WTS

CODIGO	DESCRIPCION	UND. MED.	CJ. MASTER
200005	PANTALLA LED CON REJILLA 2 x 36 WTS	UNIDAD	6 UND.

BESTLUX

LIGHTING



LED OVALADO

24
WTS

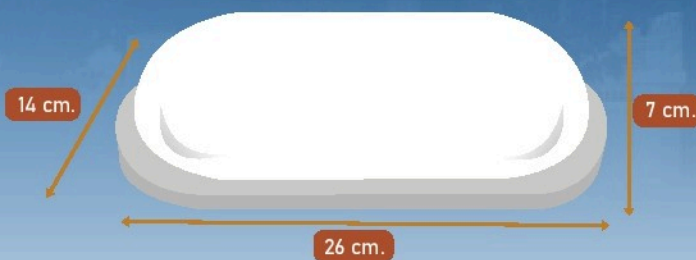
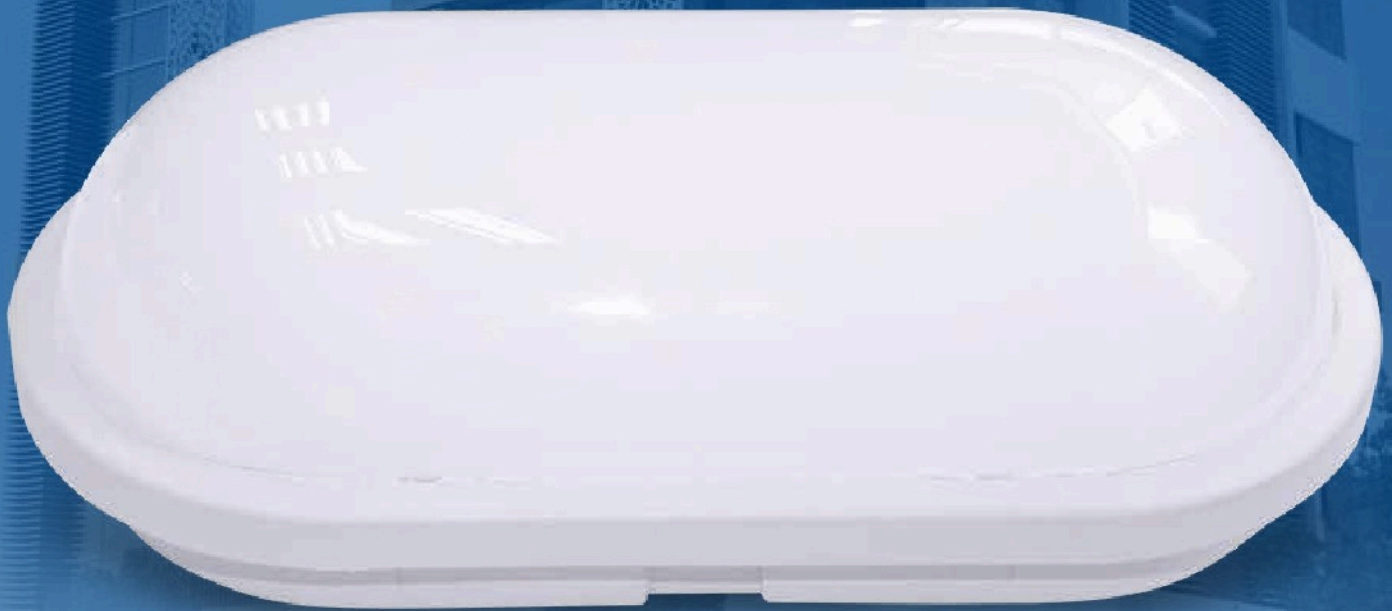

- Luz Blanca.
- Estable y duradero.



- Alto ahorro de energía.
- Ideal para iluminar área de entrada, pasillos, jardines, oficinas .

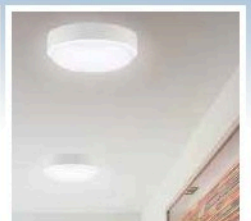
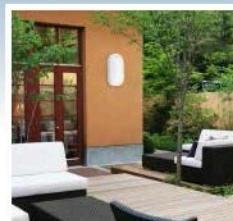

CODIGO	POTENCIA	UND. MED.	CAJA INTERNA	MASTER
272001	24 W	UNIDAD	1 UND.	20 UND.

FIJI LIGHT

PANEL CUADRADO LED



18
WTS

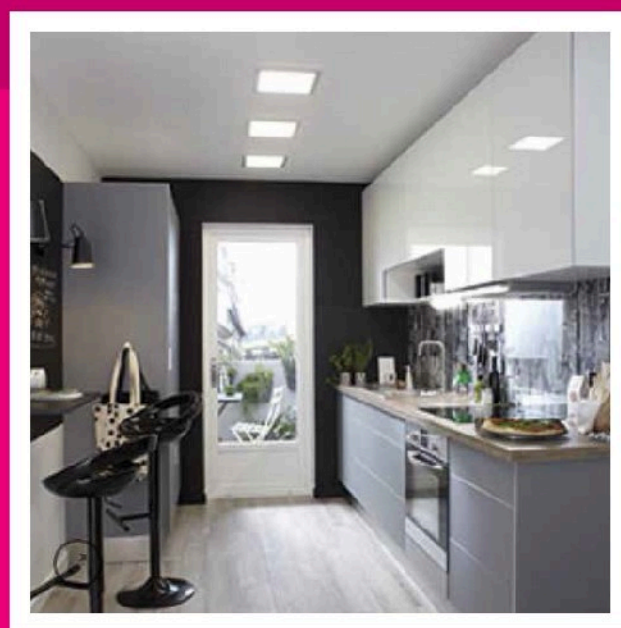

CODIGO	DESCRIPCION	MEDIDA	UND. MED.	CJ. MASTER
221004	PANEL CUADRADO LED 18 WTS	22,5 cm	UNIDAD	20 UND.

TOP LIGHT

Circular LED

Deluxe



AHORRA
80%
DE ENERGIA

24
WTS



CODIGO	DESCRIPCION	UND. MED.	CJ. MASTER
202001	CIRCULAR LED DELUXE "TOP LIGHT"	UNIDAD	10 UND.

BESTLUX

HIGH BAY INDUSTRIAL LED



CODIGO	DESCRIPCION	MEDIDA	UND. MED.	MASTER
245001	HIGH BAY LED 150WT	Ø 33,5 cm	UNIDAD	1 UND.
245002	HIGH BAY LED 200WT	Ø 38,5 cm	UNIDAD	1 UND.
245003	HIGH BAY LED 240WT	Ø 38,5 cm	UNIDAD	1 UND.

BESTLUX

Reflector LED

Buena Luminosidad.
Bajo consumo de energía.
Vidrio frontal templado.
Articulado para orientar el reflector
LED.
Resistente a la lluvia.
Para interiores y exteriores.



Se puede instalar en espacios
verdes, fachadas, patios y otros
espacios arquitectónicos
abiertos, espacios públicos,
áreas residenciales, etc.

CODIGO	DESCRIPCION	UND. MED.	CJ. MASTER
244001	REFLECTOR LED 30 WTS "BESTLUX"	UNIDAD	20 UNID
244002	REFLECTOR LED 50 WTS "BESTLUX"	UNIDAD	10 UNID
244003	REFLECTOR LED 100 WTS "BESTLUX"	UNIDAD	5 UNID
244004	REFLECTOR LED 150 WTS "BESTLUX"	UNIDAD	5 UNID

BESTLUX

LÁMPARA LED DELUXE



Características:

- . Mayor área de emisión de luz y mayor brillo
- . Cubierta de buena calidad
- . Estructura a prueba de polvo
- . Iluminación LED, ahorra energía
- . Luz constante, sin parpadeos
- . Ideal para el hogar o decoración en general

Aplicación:

Iluminación interior, Hotel, Decoración del hogar, Sala de estar o comedor, Dormitorios, Sala de reuniones, Centros comerciales, Restaurantes, Hospitales, etc.



Alto Brillo



Larga vida



Protege el medio ambiente

CODIGO	MEDIDA	UND. MED.	CJ. MASTER
247005	12 WTS	UNIDAD	50 UND.
247006	15 WTS	UNIDAD	50 UND.
247007	20 WTS	UNIDAD	50 UND.
247008	30 WTS	UNIDAD	50 UND.
247009	40 WTS	UNIDAD	30 UND.
247010	48 WTS	UNIDAD	30 UND.

PANEL LED REDONDO DOWNLIGHT



MEDIDAS REFERENCIALES

	Diámetro Interno	Diámetro Externo
4 wts	6 cm.	10 cm.
6 wts	8 cm.	10 cm.
15 wts	12.5 cm.	15 cm.
20 wts	17 cm.	22 cm.



Resorte cromado de alta calidad, puede proteger sus manos durante la instalación



6500K
Luz Blanca (fría)

Características:

- . Mayor área de emisión de luz y mayor brillo
- . Cubierta de buena calidad
- . Luz LED ultra brillante
- . Resorte de buena fuerza elástica
- . Ideal para salas, habitaciones, baños, pasillos y/o decoración en general

CODIGO	MEDIDA	UND. MED.	CJ. MASTER
249004	4 WTS	UNIDAD	90 UND.
249005	6 WTS	UNIDAD	90 UND.
249002	12 WTS	UNIDAD	30 UND.
249006	15 WTS	UNIDAD	30 UND.
249007	20 WTS	UNIDAD	30 UND.

TOP LIGHT

PANTALLA BALDOSA LED 4X18 WTS

LED



4x18
WTS

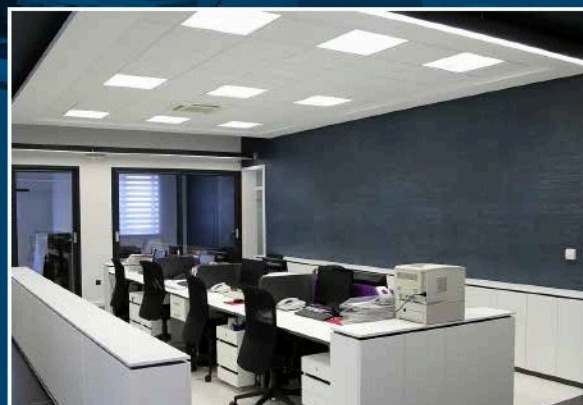

CARACTERÍSTICAS:

- Ahorro de energía.
- Gama de alto brillo, bajo consumo de energía.
- Fina estética.
- Ideal para oficinas, locales comerciales, etc.

CODIGO	DESCRIPCION	MEDIDA	UND. MED.	CJ. MASTER
162010	PANTALLA BALDOSA LED 4 x 18 WTS	60 x 60 cm	UNIDAD	4 UND.

LAMPARA DE EMERGENCIA "SCHUBERT"

LAMPARA DE EMERGENCIA "SCHUBERT"



FAROS AJUSTABLES
CON PANTALLA PRISMÁTICA.
LUZ DE LED ULTRA BRILLANTE



COMPARTIMENTO
PARA CABLE



24 

CODIGO	DESCRIPCION	UND. MED.	CJ. INTERNA	MASTER
159001	24 LED	UNIDAD	1 UND.	8 UND.

LÁMPARA DE EMERGENCIA LED CON SENSOR



Sensor de movimiento



9:30 hrs de iluminación continua

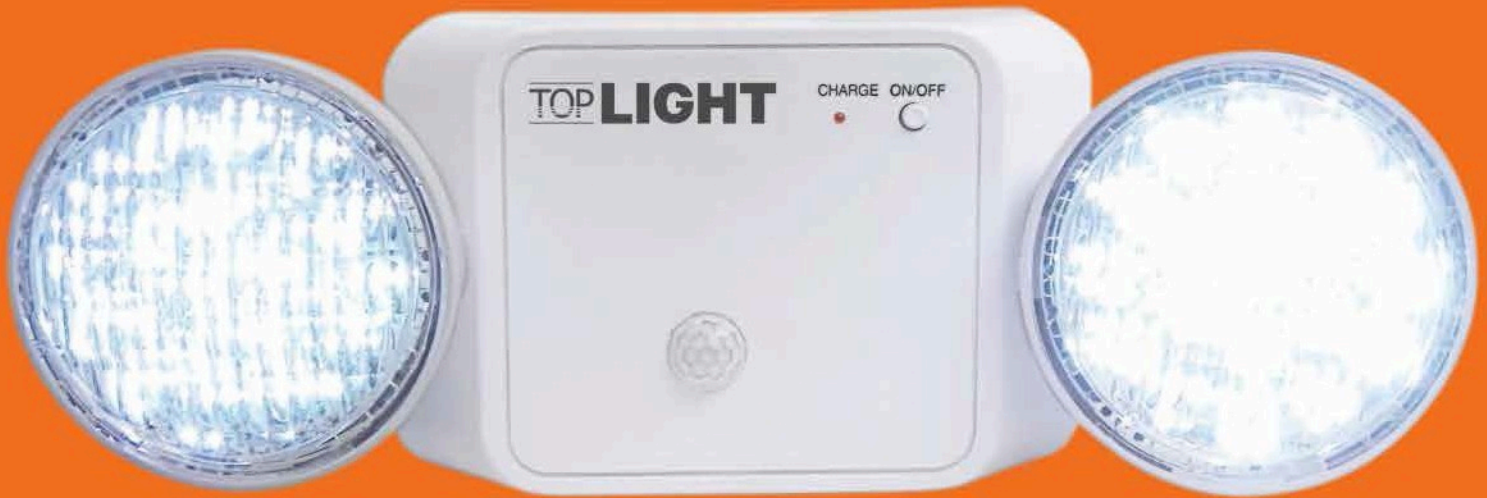

38 LED



FAROS AJUSTABLES CON PANTALLA PRISMÁTICA



PRISMAS GIRATORIOS



INDICADOR DE CARGA Y SENSOR DE MOVIMIENTO

Características:

- ✓ 38 Leds ultra brillantes luz blanca.
- ✓ Con detector de movimiento.
- ✓ Se enciende automáticamente en caso de movimiento.
- ✓ Autonomía: 9:30 horas
- ✓ Tiempo de carga de batería: 24 horas.
- ✓ Alimentación de energía con enchufe incorporado.
- ✓ Material ABS reforzado contra golpes y altas temperaturas.
- ✓ Switch on/off.
- ✓ Indicador de carga mediante 1 led.
- ✓ Temperatura de color 6000K - 7000K

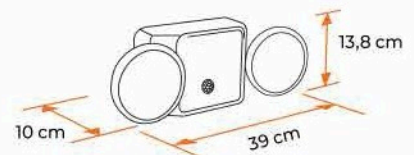

CODIGO	DESCRIPCION	UND. MED.	CJ. MASTER
159003	LÁMPARA DE EMERGENCIA LED CON SENSOR	UNIDAD	8 UND.

LÁMPARA DE EMERGENCIA DELUXE LED



2 Intensidades de iluminación



Carga mediante enchufe



5:0 Chrs de iluminación continua

60 LED

Características:

- ✓ 60Leds ultra brillante luz blanca.
- ✓ Con asa desizable para transportarla.
- ✓ Autonomía: 15 horas
- ✓ Tiempo de erga: 20 horas.
- ✓ Alimentación de energía con enchufe incorporado.
- ✓ Switch on/off.
- ✓ Luz baja y luz alta
- ✓ Temperatura de color 6000K - 7000
- ✓ Medida: 40 mm x 7 cm x 4 cm



Uso portátil o para amurar en pared o techo
Manijadeslizable para traslado
Cordón interruptor (para encender / apagar)

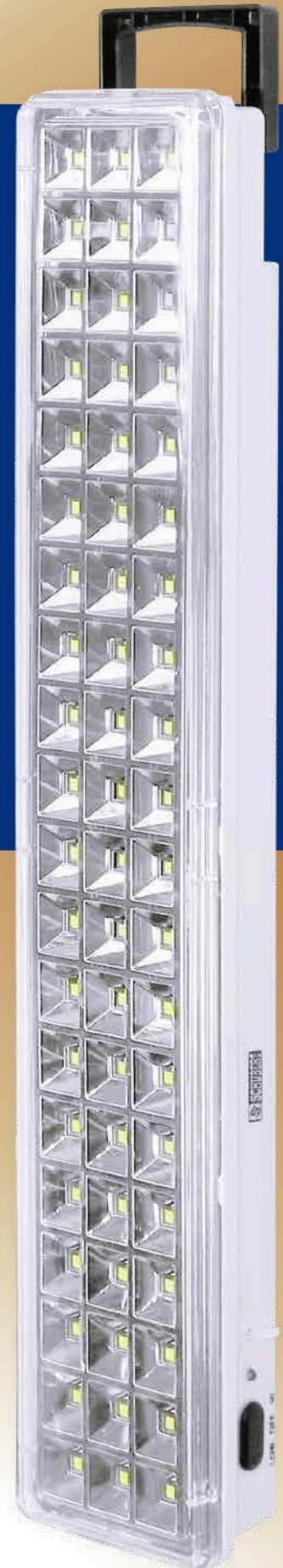

CODIGO	DESCRIPCION	MODELO	UND. MED.	CJ. MASTER
159002	LÁMPARA DE EMERGENCIA DELUXE LED	GH2912	UNIDAD	20 UND.

LINTERNA LED TIPO CAMPING CON BLUETOOTH



Recargable



Escucha la
música que
desees



2 intensidades
de iluminación



Lámpara con
Bluetooth

Características

- . Lámpara LED con parlante Bluetooth
- . Se puede escuchar música
- . 30 LED ultra brillante
- . Autonomía: 5 horas aprox.
- . Con ranura de carga micro-usb
- . Incluye cable USB
- . Medida: 8,5 cm x 21,5 cm



CODIGO	DESCRIPCION	COLOR	UND. MED.	CJ. MASTER
233003	LINTERNA LED TIPO CAMPING CON BLUETOOTH	AZUL	UNIDAD	20UND.
233004	LINTERNA LED TIPO CAMPING CON BLUETOOTH	NARANJA	UNIDAD	20UND.



15
LED



LINTERNA LED 3 EN 1 RECARGABLE

3 modos de uso:

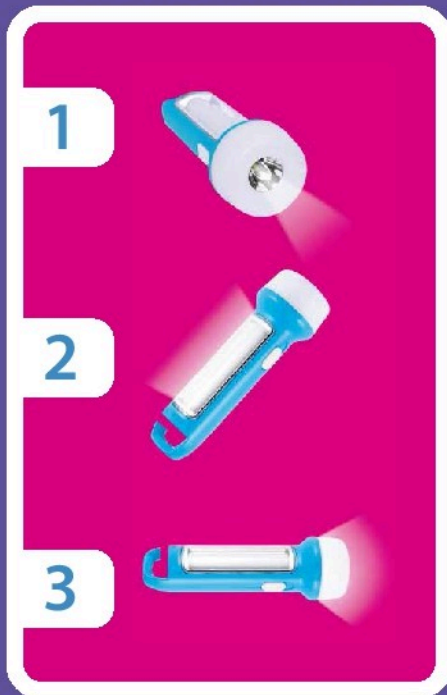

ESPECIFICACIONES:

- . Batería recargable de litio 3.7V 1.2Ah
- . 3 en 1 (1W antorcha + 15PCS LED bombilla / tubo)
- . Voltaje de recarga DC 5 V
- . Tiempo de recarga aproximadamente 6 horas
- . Tiempo de trabajo: bombilla 2 horas, antorcha 1.5 horas, luz 2 horas
- . Recarga mediante cable USB

CODIGO	COLOR	UND. MED.	MASTER
233001	AZUL	UNIDAD	40 UND.
233002	NARANJA	UNIDAD	40 UND.

TIMBRES INDUSTRIALES TIPO CAMPANA



Características:

- Se puede conectar fácilmente a un interruptor para activarla en el momento que sea necesario o instalarla en un sistema de alarma.
- No requiere ningún tipo de batería, ya que se conecta directamente a la corriente eléctrica, y puede ser colocada en interiores (medidas pequeñas) y exteriores (medidas grandes).
- Su base cuenta con orificios para sujetarla de forma segura utilizando tornillos (No incluye tornillos).



Ideal para colegios, oficinas, comunidades, institutos, universidades, etc.

CODIGO	DESCRIPCION	MEDIDA	UND. MED.	CJ. MASTER
227001	TIMBRE INDUSTRIAL T/CAMPANA	4"	UNIDAD	30 UND.
227003	TIMBRE INDUSTRIAL T/CAMPANA	8"	UNIDAD	10 UND.
227004	TIMBRE INDUSTRIAL T/CAMPANA	10"	UNIDAD	10 UND.
227005	TIMBRE INDUSTRIAL T/CAMPANA	12"	UNIDAD	7 UND.

SENSOR DE MOVIMIENTO DELUXE 120°



CARACTERÍSTICAS:

- Ángulo de detección 120°
- Switch: On / Auto / Off
- Consumo: 0.45W
- Distancia de detección: max. 9m (<24°C)
- Altura de instalación: 1m~1.8m

DESCRIPCIÓN:

Cuenta con sensor de alta sensibilidad que se activa al detectar la presencia de las personas en un rango de 120°, cuenta con un interruptor switch para la activación o desactivar el sensor de movimiento.

Este sensor puede trabajar de día y noche automáticamente.

Ideal para pasillos, escaleras, baños, etc.

CODIGO	DESCRIPCION	UND. MED.	CJ. INTERNA	CJ. MASTER
186004	SENSOR DE MOVIMIENTO DELUXE 120°	UNIDAD	10 UND.	100 UND.

SENSORES

LINEA 186



CODIGO: 186001

SENSOR AUTOMÁTICO
REF: ES-B03



CODIGO: 186003

DETECTOR DE HUMO
REF: ES-S02

CODIGO	DESCRIPCION	UND. MED.	CJ. INTERNA	CJ. MASTER
186001	SENSOR AUTOMÁTICO ES-B03	UNIDAD	25 UND.	100 UND.
186003	DETECTOR DE HUMO ES-S02	UNIDAD	-	50 UND.

EXTENSIONES

BEST LIGHT



¡DIFERENTES MEDIDAS!

CODIGO	DESCRIPCION	COLOR	UND. MED.	MASTER
130001	EXTENSION 3MT. 2 x 18	CRISTAL	UNIDAD	50 UND.
130012	EXTENSION 7MT. 2 x 18	AMARILLO	UNIDAD	20 UND.
130015	EXTENSION 25MTS	NARANJA	UNIDAD	8 UND.



AUTOMOTRIZ

- ABRAZADERAS
- LLANTAS
- HERRAMIENTAS
- PRECINTOS Y GRAPAS
- GATAS

INTEGRAL SOLUTIONS

LLANTAS PARA MOTOCICLETA

LINEA 184

FIJI

medida
3.00-18

llanta posterior

4 Lonas



Diferencia por el tipo de cocada

CODIGO	DESCRIPCION	UND. MED.	MASTER
184002	LLANTA P/MOTOCICLETA POSTERIOR (GRUESA)	UNIDAD	20 UND.
184004	LLANTA P/MOTOCICLETA TRIAL	UNIDAD	20 UND.

LLANTA PARA MOTOCICLETA



FIJI



LLANTA TRIAL HEAVY

1. Medida: 3.0 x 1 8
2. Llanta trasera
3. 100% Lona
4. Medida Cocada:
Ancho 2 cm
La rgo: 2.5 c m
Profun didad: 0.5 cm.
5. Todo tipo de relieve
(Chacarera. Hecha para los caminos de Perú, al to tránsito)

DE ALTA
CALIDAD

CODIGO	DESCRIPCION	UND. MED.	CJ. MASTER
184005	LLANTA TRIAL HEACY 3.0 X 18	UNIDAD	20 UND.

FIJI



Llanta para Motocicleta Modelo Torito

medida
4.00-8



CODIGO	DESCRIPCION	UND. MED.	MASTER
184003	LLANTA P/MOTOCICLETA MOD. TORITO 4.00 - 8 "FIJI"	UNIDAD	5 UND.

AUTOMOTRIZ



SILICONA PARA LLANTAS



CARACTERÍSTICAS:

- Se adhiere a la superficie de la llanta, resaltando su color. ■
- Restaura el lustre, dando un brillo permanente. ■
- Fácil de usar. ■

**CONTENIDO
650 ml.**

CODIGO	CANTIDAD	UND. MED.	MASTER
209007	650 ML.	UNIDAD	12 UND.

SILICONA PARA CUEROS Y TABLEROS:



**PROTECTOR
UV**

- Limpia y Protege
- Humecta y da Brillo
- Fragancia Duradera



Contenido:
450 ML.

CODIGO	DESCRIPCION	UND. MED.	MASTER
209001	SILICONA P/CUEROS Y TABLEROS FRESA	UNIDAD	12 UND.
209002	SILICONA P/CUEROS Y TABLEROS DURAZNO	UNIDAD	12 UND.
209003	SILICONA P/CUEROS Y TABLEROS MANZANA	UNIDAD	12 UND.
209004	SILICONA P/CUEROS Y TABLEROS NARANJA	UNIDAD	12 UND.
209005	SILICONA P/CUEROS Y TABLEROS JAZMIN	UNIDAD	12 UND.
209006	SILICONA P/CUEROS Y TABLEROS ROSAS	UNIDAD	12 UND.

UNIDAD DE NEGOCIO:

AUTOMOTRIZ

LINEA 022

ABRAZADERAS



ABRAZADERAS SIN FIN - TAIWAN



CODIGO	MEDIDA	UND. MED.	CAJA	MASTER
022011	2 1/4"	CIENTO	1 CIENTOS	10 CIENTOS
022013	2 3/4"	CIENTO	1 CIENTOS	10 CIENTOS



Herramientas

TOP SCHUBERT



INTEGRAL SOLUTIONS



RACHET REVERSIBLE

CODIGO	MEDIDA	UND. MED.	INTERNA
136047	1/2"	UNIDAD	UNIDAD



VOLTÍMETRO DIGITAL

CODIGO	DESCRIP.	UND. MED.
136145	DIGITAL	UNIDAD



WINCHA 3 MT. C/AZUL

CODIGO	MEDIDA	UND. MED.	INTERNA	MASTER
136181	3 MT	UNIDAD	10 UND.	120 UND.



ESCUADRA DE COMBINACION 12"

CODIGO	MEDIDA	UND. MED.	MASTER
136068	12"	UNIDAD	25 DOC.



Herramientas

TOP SCHUBERT



INTEGRAL SOLUTIONS



LLAVE MIXTA CON RACHET

CODIGO	MEDIDA	UND. MED.	INTERNA
136036	15 MM	UNIDAD	UNIDAD



LLAVE MIXTAS PULGADAS

CODIGO	MEDIDA	UND. MED.	INTERNA	MASTER
138027	1/2"	UNIDAD	10 UND.	300 UND.
138023	1/4"	UNIDAD	10 UND.	1000 UND.
138024	3/8"	UNIDAD	10 UND.	500 UND.
138025	5/16"	UNIDAD	10 UND.	800 UND.



DESARMADOR PLANO

CODIGO	MEDIDA	UND. MED.
136109	1/8" X 3"	UNIDAD
136113	1/4" x 4"	UNIDAD
136111	3/16" x 3"	UNIDAD



Herramientas

TOP SCHUBERT



INTEGRAL SOLUTIONS



ADAPTADOR CROMADO P/RACHET

CODIGO	MEDIDA	UND. MED.	MASTER
136060	1/2"	UNIDAD	20 UND.



EXTENSION P/RACHET

CODIGO	MEDIDA	UND. MED.
136063	10"	UNIDAD
136062	5"	UNIDAD

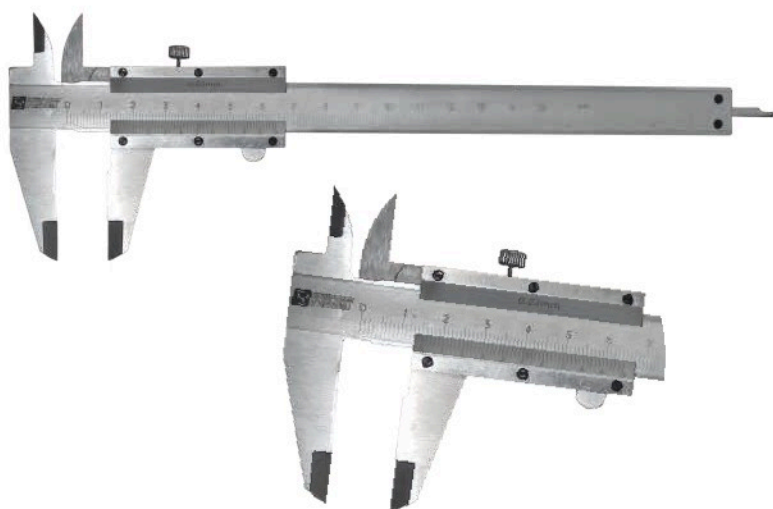

CALIBRADOR "SCHUBERT"

CODIGO	MEDIDA	TIPO	UND. MED.	INTERNA	MASTER
136073	6"	METÁLICO	UNIDAD		50 UND.



KIT DE DESARMADORES

CODIGO	DESCRIPCIÓN	UND. MED.
136230	KIT DESARMADORES	UNIDAD

PRECINTOS DE NYLON Y GRAPAS PARA CABLE

COLOR BLANCO

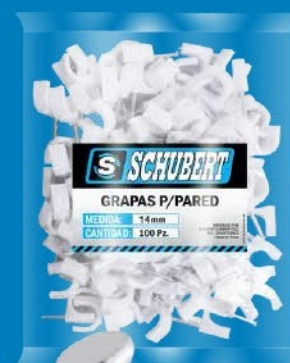
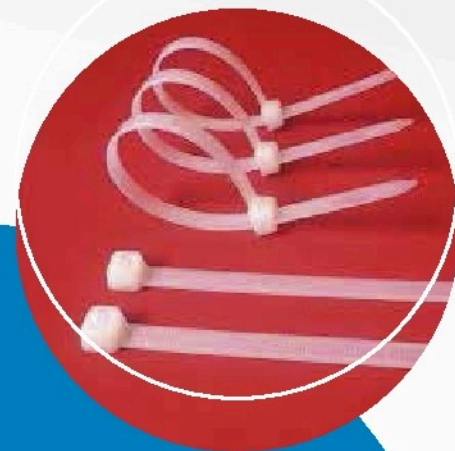

PRECINTO DE NYLON

CODIGO	MEDIDA	UND. MED.	MASTER
156001	2.5 x 100MM	CTO.	450 CTO.
156003	3.6 x 150MM	CTO.	350 CTO.
156005	4.8 x 200MM	CTO.	125 CTO.
156007	4.8 x 300MM	CTO.	100 CTO.

GRAPAS P/CABLE

CODIGO	MEDIDA	UND. MED.	MASTER
156021	10MM	CTO.	100 CTO.
156022	12MM	CTO.	100 CTO.
156023	14MM	CTO.	80 CTO.
156024	16MM	CTO.	50 CTO.
156019	6MM	CTO.	200 CTO.

UNIDAD DE NEGOCIO:
AUTOMOTRIZ

LINEA 156

PRECINTOS



PRECINTOS DE NYLON



PRECINTO DE NYLON C/NEGRO

CODIGO	MEDIDA	UND. MED.	MASTER
156027	2.5 x 100MM	CTO.	450 CTO.

Aplicación:

Los precintos Schubert son ideales para instalaciones temporales, sujetan firmemente otorgando seguridad y pueden removerse fácilmente al terminar. Ideal también para cualquier otra necesidad de fijación y atado que requieren seguridad y calidad.

- Trabajan de una manera sencilla y práctica para atar y fijar.
- Disponibles en varios tamaños.
- Mecanismo de cierre automático.

CABLE PARA BATERIA

CABLE PARA BATERIA DE CAMION (BOLSA)

BEST LIGHT



CODIGO	MEDIDA	UND. MED.	MASTER
130013	24 VOLTIOS / 400 AMP 3.5MM x 3MT	UNIDAD	5 UND.

CABLE P/BATERIA D/AUTO X 3.7MT 8AWG

BEST LIGHT



CODIGO	MEDIDA	UND. MED.	MASTER
130007	3.7 MT	UNIDAD	5 UND.

DESARMADOR INTERCAMBIABLE

▶ HERRAMIENTAS



CODIGO	UND. MED.	MEDIDA	CJ. INTERNA	CJ. MASTER
152006	DOCENA	3x60mm	1 DOC.	40 DOC.
152007	DOCENA	5x75mm	1 DOC.	30 DOC.
152008	DOCENA	6x90mm	1 DOC.	25 DOC.

LLAVE FRANCESA

MANGO AMARILLO

▶ HERRAMIENTAS



Escala Métrica
en Pulgadas

CODIGO	UND. MED.	MEDIDA	CJ. INTERNA	CJ. MASTER
152002	UNIDAD	6"	6 UND.	120 UND.
152001	UNIDAD	8"	6 UND.	120 UND.
152003	UNIDAD	10"	6 UND.	60 UND.
152004	UNIDAD	12"	6 UND.	36 UND.



INTEGRAL S.R.L.
SOLUTIONS

CERRAJERIA

- CANDADOS
- BISAGRAS
- CORREDERAS
- PISTÓN
- CERRADURA
- ZIG ZAG
- CIERRE MAGNÉTICO
- REMACHES DE ALUMINIO

CERRAJERIA

LINEA 155

CANDADOS DE BRONCE "PAOX"



CANDADOS DE BRONCEADOS "PAOX"



CODIGO	MEDIDA	ACABADO	UND. MED.	CAJA	MASTER
155001	20MM	BRONCE	UNIDAD	12 UND.	240 UND.
155002	25MM	BRONCE	UNIDAD	12 UND.	240 UND.
155003	32MM	BRONCE	UNIDAD	12 UND.	120 UND.
155004	38MM	BRONCE	UNIDAD	12 UND.	96 UND.
155006	50MM	BRONCE	UNIDAD	12 UND.	72 UND.
155007	63MM	BRONCE	UNIDAD	6 UND.	48 UND.
155008	75MM	BRONCE	UNIDAD	6 UND.	36 UND.

UNIDAD DE NEGOCIO:

CARPINTERÍA

LINEA 126

PISTON A GAS PARA MUEBLE



PISTON A GAS PARA MUEBLE



CODIGO	MODELO	SOPORTE APROX.	UND. MED.	INTERNA	MASTER
126019	120 N	12 K.	UNIDAD	20 UND.	100 UND.
126015	100 N	10 K.	UNIDAD	20 UND.	100 UND.
126017	80 N	8 K.	UNIDAD	20 UND.	100 UND.

UNIDAD DE NEGOCIO:

CARPINTERÍA

LINEA 228



PAOX

CORREDERAS
TELESCOPICAS
CON FRENO



Incluye
tornillos



27 mm
Ancho

Corredora para cajón que permite un total acceso al interior del mismo. Posee un freno de retención para evitar rupturas.

CODIGO	MEDIDA	UND. MED.	CJ. MASTER
228004	Largo: 16" / Ancho: 27mm	JGO.	30 JGOS.
228005	Largo: 18" / Ancho: 27mm	JGO.	30 JGOS.



CERRADURA PARA VITRINA

LÍNEA 126



CODIGO	MODELO	UND. MED.	INTERNA	MASTER
126009	318	DOCENA	1 DOC.	20 DOC.

UNIDAD DE NEGOCIO:

CARPINTERÍA

LINEA 126

CIERRE Y ZIGZAG "SCHUBERT"



ZIGZAG D/RODILLO

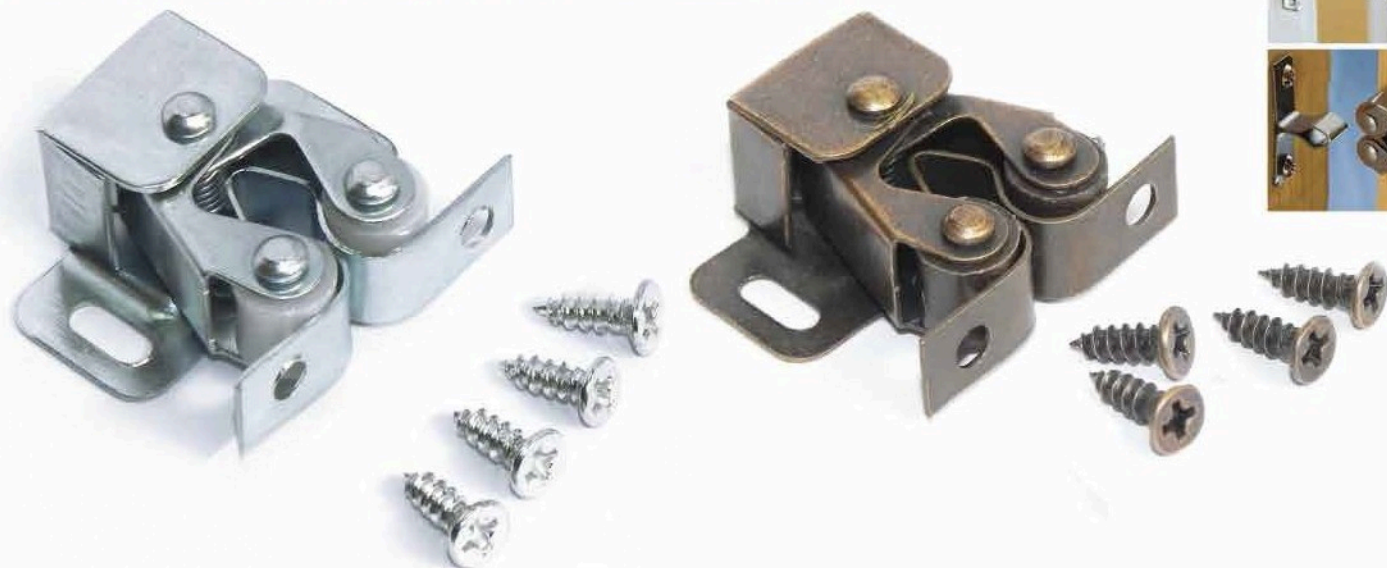

CODIGO	DESCRIPCION	UND. MED.	CJ. INTERNA	CJ. MASTER
126021	ZIG ZAG D/RODILLO C/MARRON	CIENTO	1 CTO.	10 CTOS.
126022	ZIG ZAG D/RODILLO C/ZINCADO	CIENTO	1 CTO.	10 CTOS.

CIERRE MAGNÉTICO



CODIGO	DESCRIPCION	UND. MED.	CJ. INTERNA	CJ. MASTER
126023	CIERRE MAGNÉTICO C/MARRÓN	CIENTO	1 CTO.	10 CTOS.

FIJI

BISAGRAS PARA PUERTAS

LINEA 275



BISAGRAS FIJAS ALUMINIZADAS



**BISAGRA FIJA
ALUMINIZADA**

CON TORNILLO

MEDI DA: 3.5"X1.60 mm



**BISAGRA FIJA
ALUMINIZADA**

CON TORNILLO

MEDI DA: 4"X1.80 mm

CODIGO	DESCRIPCIÓN	UND. MED	CJ. INTERNA	CJ. MASTER
275008	BISAGRA FIJA ALUMINIZADA 3 1/2" X 1.60 mm	CAJA	10 PARES	150 PARES
275009	BISAGRA FIJA ALUMINIZADA 4" X 1.80 mm	CAJA	10 PARES	120 PARES
275007	BISAGRA FIJA ALUMINIZADA 3"	CAJA	10 PARES	240 PARES

FIJI BISAGRAS PARA PUERTAS

LINEA 275



BISAGRAS FIJAS ZINCADAS



**BISAGRA FIJA
ZINCADA**

SIN TORNILLO

MEDI DA: 3"X1.60 mm



**BISAGRA FIJA
ZINCADA**

SIN TORNILLO

MEDI DA: 4"X1.80 mm

CODIGO	DESCRIPCIÓN	UND. MED	CJ. INTERNA	CJ. MASTER
275010	BISAGRA FIJA ZINCADA 3" X 1.60 mm	CAJA	10 PARES	240 PARES
275012	BISAGRA FIJA ZINCADA 4" x 1.80 mm	CAJA	10 PARES	120 PARES
275011	BISAGRA FIJA ZINCADA 3 1/2"	CAJA	10 PARES	150 PARES

FIJI

BISAGRAS PARA PUERTAS

LINEA 275



BISAGRAS CAPUCHINAS BRONCEADAS

Permite desmontar la
puerta. Bisagra reusable

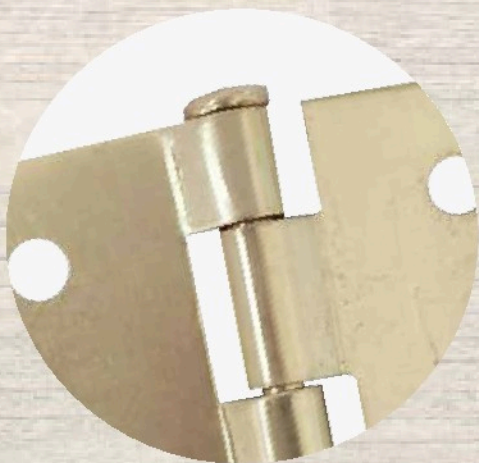

**BISAGRA CAPUCHINAS
BRONCEADA**

CON TORNILLO

MEDI DA: 3"X3"X1.50 mm

CODIGO	DESCRIPCIÓN	UND. MED.	CJ. MASTER
275004	BISAGRA CAPUCHINA BRONCEADA 3" X 3"	PAR	100 PARES
275006	BISAGRA CAPUCHINA BRONCEADA 4" X 4"	PAR	50 PARES
275005	BISAGRA CAPUCHINA BRONCEADA 3 1/2" X 3 1/2"	PAR	50 PARES

FIJI

BISAGRAS PARA PUERTAS

LINEA 275



BISAGRAS CAPUCHINAS ALUMINIZADAS

Permite desmontar la
puerta. Bisagra reusable

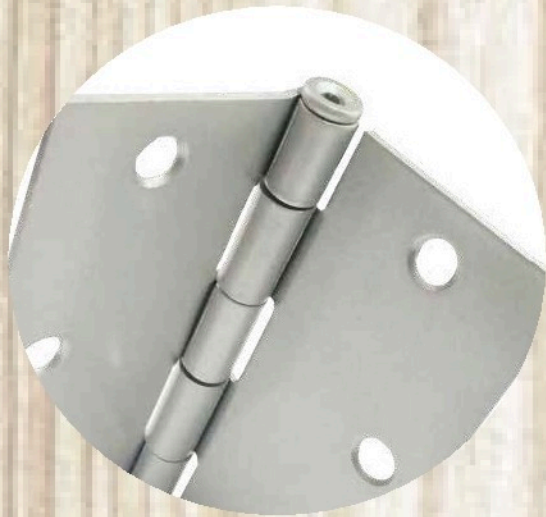

**BISAGRA CAPUCHINAS
ALUMINIZADAS**

CON TORNILLO

MEDI DA: 3.5"X3.5"X1.60MM



CODIGO	DESCRIPCIÓN	UND. MED.	C.J. MASTER
275002	BISAGRA CAPUCHINA ALUMINIZADA 3 1/2" X 3 1/2"	PAR	50 PARES
275001	BISAGRA CAPUCHINA ALUMINIZADA 3" X 3"	PAR	100 PARES
275003	BISAGRA CAPUCHINA ALUMINIZADA 4" X 4"	PAR	50 PARES

FIJI



Bisagras Cangrejo

Línea 256



Modelo: Interior



Modelo: Lateral



*Presentación
en Bolsa*

CODIGO	DESCRIPCION	UND. MED.	MASTER
256001	BISAGRA T/CANGREJO LATERAL (HG201A)	PAR	100 PARES
256003	BISAGRA T/CANGREJO INTERIOR (HG201C)	PAR	100 PARES



CONSUMO MASIVO

- CUCHILLA CUTTER
- CABLES PARA CELULARES
- BATERIA PARA CELULARES
- CAR CHARGER
- STRETCH FILM
- TERMÓMETRO
- CINTA DE LUCES LED
- LLAVEROS
- GATILLO SPRAYER

CONSUMO MASIVO

CUCHILLAS CUTTERS

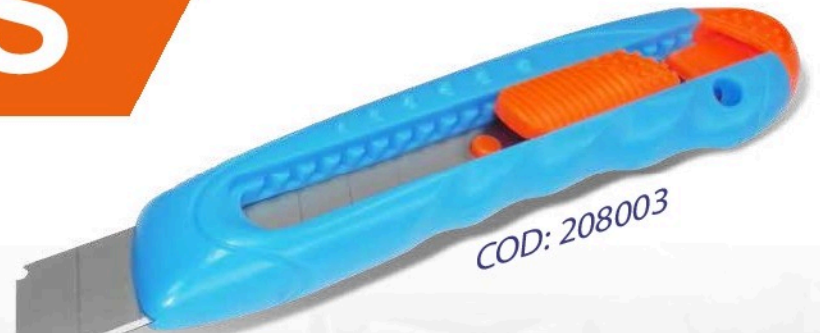

COD: 208003



COD: 208006



COD: 208001



COD: 208004

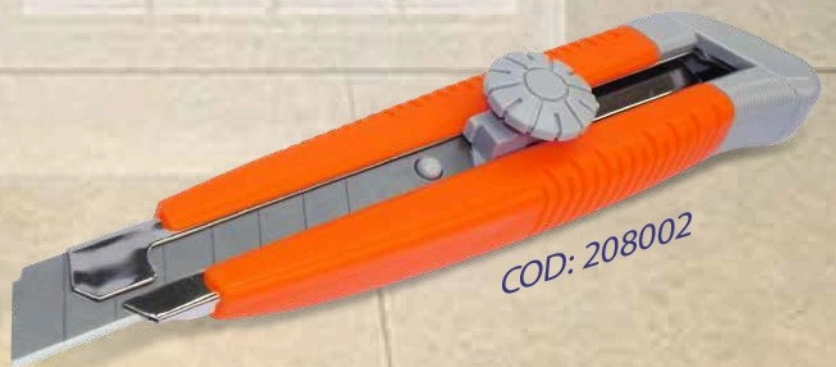

COD: 208002

CODIGO	DESCRIPCION	UND. MED.	CJ. INTERNA	MASTER
208001	CUCHILLA CON MANGO SOFT MOD: SX722	UNIDAD	20 UND.	200 UND.
208002	CUCHILLA CUTTER MOD: SX69	UNIDAD	12 UND.	144 UND.
208003	CUCHILLA CUTTER MOD: SX820L	UNIDAD	12 UND.	288 UND.
208004	CUCHILLA CUTTER MOD: SX825L	UNIDAD	12 UND.	288 UND.
208006	CUCHILLA GIRATORIA MOD: SX766-1	UNIDAD	12 UND.	144 UND.

TOP LIGHT

LED NEON STRIP



LED

- **40**
Watts
- **220V**
- **5 m**

CARACTERÍSTICAS:

- Luz Neón LED
- Tubo flexible
- 120 LED / metro
- 8 WTS / metro
- 8 distintos modos de iluminación
- Medida: 5m x 13 mm (diámetro)
- Bajo consumo de energía.
- Larga vida y durabilidad
- Lineal y continua el efecto de la luz
- IP67



**CUENTA CON CONTROL
DE CAMBIOS DE COLORES**

APLICACIÓN:

Ideal para Discotecas, Bar Pub, Fiesta navideña, Hoteles, Decoración en general.

CODIGO	DESCRIPCION	MEDIDA	UND. MED.	CJ. MASTER
213004	NEON STRIP LED	5 MTS	UNIDAD	6 UND.

LINEA 197

Bateria para celular

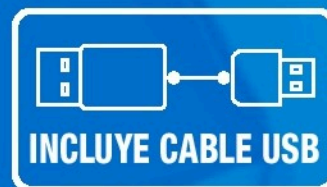

Las baterías para celular, poseen un sistema de protección inteligente está construido en forma efectiva para evitar la sobrecarga y cortocircuito. Es estable, fiable y seguro.

CODIGO	COLOR	DESCRIPCION	UND. MED.	CJ. MASTER
197004	BLANCO	8000 mAh	UND.	40 UNID.

Baterias p/celular

LINEA 197

Bateria para celular c/amarillo



iPhone



Android



iPad



Tablet



Cámara



Videojuegos



MP4/MP3

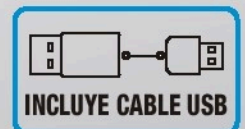

CODIGO	DESCRIPCION	UND. MED.	CJ. MASTER
197002	2000 mAh	UND.	100 UNID.

Cables para Celulares

LINEA 190

RAPID A
TRANSE REN CIA
DE D ATOS



LONGITUD: 1 MT

► Cable para Smartphone

MOD: TR2076



Compatible con:

- Samsung Edge
- Samsung Galaxy
- Moto X / G / E
- Sony Xperia
- Nokia
- HTC
- Huawei
- Tablet
- Laptop



Dispositivos compatibles:

Smartphone Tablet Laptop

Colores:



CODIGO	DESCRIPCION	COLOR	UND. MED.	INTERNA	MASTER
190002	CABLE P/SMARTPHONE MOD: TR2076	NEGRO	UND.	50 UNID.	100 UNID.
190010	CABLE P/SMARTPHONE MOD: TR2076	BLANCO	UND.	50 UNID.	100 UNID.
190011	CABLE P/SMARTPHONE MOD: TR2076	AZUL	UND.	50 UNID.	100 UNID.
190014	CABLE P/SMARTPHONE MOD: TR2076	VERDE	UND.	50 UNID.	100 UNID.

Cables para Celulares

LINEA 190

RAPIDA
TRANSFERENCIA
DE DATOS



LONGITUD: 1 MT

► Cable type C

MOD: TR2077



Compatible con:

- Huawei P9 / P10
- Samsung Galaxy S8 / Note 8
- Moto Z
- LG Nexus

Colores:



TYPE C



CODIGO	DESCRIPCION	COLOR	UND. MED.	MASTER
190035	CABLE TYPE C MOD: TR2077	AZUL	UND.	100 UNID.
190037	CABLE TYPE C MOD: TR2077	NARANJA	UND.	100 UNID.
190036	CABLE TYPE C MOD: TR2077	ROSADO	UND.	100 UNID.
190032	CABLE TYPE C MOD: TR2077	VERDE	UND.	100 UNID.

Cables para Celulares

LINEA 190

RAPIDA
TRANSFERENCIA
DE DATOS

LONGITUD: 1 MT

► Cable para iPhone

MOD: TR207 5



Compatible con:

- iPhone 6 / 6S
- iPhone 6 Plus / 6S Plus
- iPhone 5 / 5C / 5S
- iPad Air
- iPad mini
- iPad
- iPad touch
- iPad nano



Dispositivos compatibles:

iPhone iPad iPod

Colores:



CODIGO	DESCRIPCION	COLOR	UND. MED.	INTERNA	MASTER
190001	CABLE P/IPHONE MOD: TR2075	NEGRO	UND.	50 UNID.	100 UNID.
190006	CABLE P/IPHONE MOD: TR207	AZUL	UND.	50 UNID.	100 UNID.
190008	CABLE P/IPHONE MOD: TR2075	NARANJA	UND.	50 UNID.	100 UNID.
190007	CABLE P/IPHONE MOD: TR2075	ROSADO	UND.	50 UNID.	100 UNID.
190005	CABLE P/IPHONE MOD: TR2075	BLANCO	UND.	50 UNID.	100 UNID.

Cables para Celulares

LINEA 190

RAPIDA
TRANSFERENCIA
DE DATOS



LONGITUD: 1 MT

► Cable 2 en 1

MOD: TR3064



Compatible con:

- iPhone X / S7 / S6
- Samsung
- Huawei
- Moto X / G / E
- Sony Xperia
- HTC
- Huawei
- Tablet
- Laptop

Colores:



**MICRO USB +
IPHONE**

CODIGO	DESCRIPCION	COLOR	UND. MED.	MASTER
190040	CABLE 2 EN 1 MOD:TR3064	AZUL	UND.	100 UNID.
190039	CABLE 2 EN 1 MOD:TR3064	BLANCO	UND.	100 UNID.
190043	CABLE 2 EN 1 MOD:TR3064	NARANJA	UND.	100 UNID.
190038	CABLE 2 EN 1 MOD:TR3064	NEGRO	UND.	100 UNID.
190041	CABLE 2 EN 1 MOD:TR3064	ROSADO	UND.	100 UNID.

Cables para Celulares

LINEA 190

► Cable Auxiliar 3.5 mm

MOD: TR2024



Colores:



CODIGO	DESCRIPCION	COLOR	UND. MED.	INTERNA	MASTER
190045	CABLE AUXILIAR 3.5MM MOD: TR2024	NEGRO	UND.	50 UNID.	100 UNID.
190003	CABLE AUXILIAR 3.5MM MOD: TR2024	ROSADO	UND.	50 UNID.	100 UNID.



Cargador de Auto Universal



Diseño especial con punta de acero inoxidable, puede romper vidrio.

Carga 2 dispositivos a la vez.
Compatible con iPhone, iPad, Smartphones, Tablet



CODIGO	DESCRIPCION	UND. MED.	CJ. MASTER
190024	CARGADOR D/AUTO UNIVERSAL C/NEGRO	UNIDAD	100 UND.
190025	CARGADOR D/AUTO UNIVERSAL C/BLANCO	UNIDAD	100 UND.
190026	CARGADOR D/AUTO UNIVERSAL C/DORADO	UNIDAD	100 UND.
190027	CARGADOR D/AUTO UNIVERSAL C/PLATA	UNIDAD	100 UND.
190028	CARGADOR D/AUTO UNIVERSAL C/ROJO	UNIDAD	100 UND.
190029	CARGADOR D/AUTO UNIVERSAL C/MARRON	UNIDAD	100 UND.
190030	CARGADOR D/AUTO UNIVERSAL C/AZUL	UNIDAD	100 UND.
190031	CARGADOR D/AUTO UNIVERSAL C/MORADO	UNIDAD	100 UND.

LÍNEA 242 | LLAVEROS SCHUBERT

LLAVERO ACRÍLICO



CANTIDAD:

24
PIEZAS

CODIGO	DESCRIPCION	MODELO	UND. MED.	CJ. INTERNA	CJ. MASTER
242003	LLAVERO ACRÍLICO	SDM001	UNIDAD	48 UNID.	96 UNID.

LLAVERO OVALADO



CANTIDAD:

50
PIEZAS

CODIGO	DESCRIPCION	MODELO	UND. MED.	CJ. INTERNA	CJ. MASTER
242001	LLAVERO OVALADO	SDM003	UNIDAD	50 UNID.	96 UNID.

LLAVERO MEDIA LUNA



CANTIDAD:

36
PIEZAS

CODIGO	DESCRIPCION	MODELO	UND. MED.	CJ. INTERNA	CJ. MASTER
242002	LLAVERO MEDIA LUNA	SDL038	UNIDAD	48 UNID.	96 UNID.



TERMÓMETRO INFRARROJO



Características:

- 1 Mide la temperatura a distancia
- 2 Respuesta Inmediata
- 3 Pantalla LCD con retroiluminación
- 4 Sensor de alta Precisión
- 5 Operación presionando el gatillo.
- 6 Compartimiento para pilas
- 7 Unidades en °C / °F
- 8 Botones de Configuración



CODIGO	DESCRIPCIÓN	UND. MED.
273001	TERMÓMETRO "ANU"	UNIDAD

FERRETERÍA

LINEA 274

GATILLO SPRAYER



“GATILLO SPRAYER”

CARACTERÍSTICAS:

Cabezal de pulverizador cómodo.
Boquilla regulable.
Aspira líquido para micro pulverizarlo en diminutas gotitas.



VERDE - BLANCO



NEGRO - BLANCO



AZUL - BLANCO



ROJO - BLANCO

CÓDIGO	DESCRIPCIÓN	BOLSA	CJA. MASTER
274001	GATILLO SPRAYER C/ROJO - BLANCO "SCHUBERT"	1 CIENTO	5 CIENTOS
274003	GATILLO SPRAYER C/VERDE - BLANCO "SCHUBERT"	1 CIENTO	5 CIENTOS
274004	GATILLO SPRAYER C/AZUL - BLANCO "SCHUBERT"	1 CIENTO	5 CIENTOS
274005	GATILLO SPRAYER C/NEGRO - BLANCO "SCHUBERT"	1 CIENTO	5 CIENTOS

STRETCH FILM "SCHUBERT"



STRETCH FILM

LÍNEA 188

CARACTERÍSTICAS

- Alto brillo y transparencia
- Máxima resistencia

APLICACIONES

- Protección de productos
- Almacenaje y transporte
- Optimiza el ordenamiento de productos



CODIGO	DESCRIPCION	UND. MED.	MASTER
188002	STRETCH FILM 20" SCHUBERT	UNIDAD	4 UND.

CONSUMO MASIVO

LINEA 157

CINTA DE EMBALAJE



Cinta de Embalaje



CARACTERÍSTICAS

- Buen pegamento
- Cinta transparente
- Presentación en tira de 6 unidades (rollos).



Dos medidas:
110 YD y 45 YD.

CODIGO	MEDIDA	UND. MED.	CAJA INTERNA	MASTER
157001	2 x 110 YD	ROLLO	6 ROLLOS	36 ROLLOS
157002	2 x 45 YD	ROLLO	6 ROLLOS	36 ROLLOS